



BIKE REF FOR ORDERS :  
23-FACTORYSP2-150-STD

1.1.2023

BIKE NAME : FACTORY SP2 2023





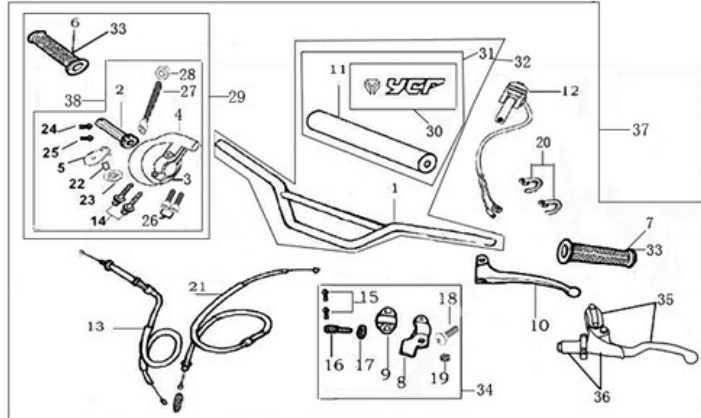





**Handle bar assembly**







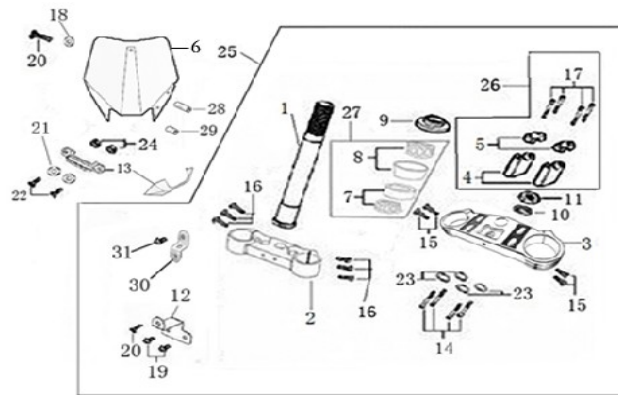

- 50A = YCF50A
- 50E = YCF50E
- W88E = START W88E
- L88 = LITE88
- L125 =
- LITE125
- S88S = START F88S
- S125S = START F125S
- S125SE = START F125SE
- S125 = START F125
- P88 = PILOT 88
- P125 = PILOT 125
- P150 = PILOT 150
- SM125 = START SM125S
- SM150 = PILOT SM 150
- SP1 = FACTORY SP1
- SP2 = FACTORY SP2
- SP3 = FACTORY SP3
- B125 = BIGY 125MX
- B150 = BIGY 150MX
- BF150 = BIGY F150MX
- BFD190 = BIGY FD190MX
- BFZ190 = BIGY ZE190 MX
- S147 = SUNDAY 150
- S187 = SUNDAY 190

| N° | Ref.          | Description   | Français  | Picture | Qty/Bike | Model  |
|----|---------------|---|---|---------|----------|--|
| 1  | GALOW-BK      | Aluminium Handle Bar, "LOW" shape BLACK L=740mm         | Guidon aluminium NOIR BAS L=740mm                                 |         | 1        | SM1501821/SP21821  |
| 11 | YC110-0131-03 | Complete Bar Pad for Chromolly Handlebar L=200mm BLACK  | Mousse guidon complete pour guidon Chromolly L=200mm NOIR         |         | 1        | SM1501821/SP21821/BF1501821/BFZ1901821   |
| 14 | YC110-0153-01 | Handle bar plastic cap,Nylon,Black                      | Embout plastique de guidon,nylon,noir                             |         | 1        | ALL BIKES 2120   |
| 15 | YC110-0138-03 | YCF complete Throttle Assy. 2020 with YCF GREY          | Poignée gaz complete YCF 2020 avec Paire de poignée YCF GRIS 2020 |         | 1        | SM1501420/SP11417/SP21421/SP31421/BF1501721/BFD1901721/BFZ1901721/S1471821/S1871821                                      |
| 23 | GB819-M4x12   | Countersunk cross head machine screw M4x12mm            | Vis à tête fraisée plate cruciforme M4x12mm                       |         | 1        | ALL BIKES 1220   |
| 24 | GB819-M4x20   | Countersunk cross head machine screw M4x20mm            | Vis à tête fraisée plate cruciforme M4x20mm                       |         | 1        | ALL BIKES 1220   |
| 25 | GB70-M6x25    | HEXAGON SOCKET Head Bolt M6x25mm                        | Vis Allen (BTR) M6x25mm   |         | 2        | ALL BIKES 1220   |
| 27 | PPC011-GY     | YCF set of grip GREY 2020                               | Paire de poignée caoutchouc YCF GRISE 2020                        |         | 1        | ALL BIKES 21   |
| 30 | YC110-0135-02 | clutch adjustable complete bracket with lever 2020 GREY | Cocotte réglage rapide avec levier embrayage 2020 GRIS            |         | 1        | S12521/P12521/P15021/SM15021/SP221/SP321/B12520/B15021/BFD19020/BFZ19021/S14720/S18721                                   |
| 31 | YC110-0151-02 | Rubber on clutch lever adjustable screw 2020            | Caoutchouc levier embrayage molette réglage 2020                  |         | 1        | S12521/P12521/P15021/SM15021/SP221/SP321/B12520/B15021/BFD19020/BFZ19021/S14720/S18721                                   |
| 32 | YC110-0136-02 | Rubber on clutch lever                                  | Caoutchouc levier embrayage                                       |         | 1        | S1251820/P1251821/P1501821/SM1501821/SP21821/SP31820/B1251821/B1501821/BF1501821/BFD1901821/BFZ1901821/S1471821/S1871821 |
| 33 | YC110-0134-04 | Clutch bracket Assy 2020 GREY                           | Cocotte embrayage complete 2020 GRIS                              |         | 1        | S12521/P12521/P15021/SM15021/SP221/SP321/B12520/B15021/BFD19020/BFZ19021/S14720/S18721                                   |

|    |                |  |   |  |   |   |
|----|----------------|--|---|--|---|---|
| 38 | BT08-M6x20-W   | HEXAGON Torx screw with Flange M6x20mm   | Vis HEXAGONALE Torx avec Flange M6x20mm   |     | 2 | ALL BIKES 21  |
| 39 | YC110-0103-07  | Clutch lever 2020 Al (with FB13-8x10x10.5-Cu 1EA FB13-8x10x9.4-Cu 1EA FB20-10x16x1 1EA) complete with bushings | Levier embrayage 2020 (avec FB13-8x10x10.5-Cu 1EA FB13-8x10x9.4-Cu 1EA FB20-10x16x1 1EA) avec entretoises |   | 1 | S12521/P12521/P15021/SM15021/SP221/SP321/B12520/B15021/BF19020/BFZ19021/S14720/S18721   |
| 49 | 27-06025B      | Clutch Stepped bolt with offset M6x25mm  | Vis cloche embrayage avec deport, M6x25mm   |   | 1 | L1251621/S1251220/P1251321/P1501220/SM1501220/SP21221/SP31220/B1251721/B1501721/BF1501721/BF01901721/BFZ1901821/S1471821/S1871821 |
| 50 | 6183-06000B    | Clutch Self-lock Nut M6 for clutch lever   | ecrou cloche embrayage M6 pour Levier embrayage 2020  |   | 1 | L1251621/S1251220/P1251321/P1501220/SM1501220/SP21221/SP31220/B1251721/B1501721/BF1501721/BF01901721/BFZ1901821/S1471821/S1871821 |
| 51 | YC110-0105-15  | Kill Switch ON/OFF L=580mm Waterproof  | Coupe circuit on off L=580mm ETANCHE  |   | 1 | ALL BIKES 1220  |
| 52 | YC110-0106     | Throttle Cable L=840mm A+B=120mm(FOR NIBBI PE19)   | Cable gaz L=840mm A+B=120mm(POUR NIBBI PE19)  |   | 1 | L12521/S12551319/S12521/S1255E1521/P1251321/P1501220/SM1251320/SM1501320/SP11217/SP21221/S1471821/S1871821                        |
| 53 | YC110-0143-01  | Rubber on trottle cable  | Protection caoutchouc cable de gaz  |   | 1 | ALL BIKES 1720  |
| 54 | YC110-01-03-BK | Cable tie, nylon, L=150mm BLACK  | collier maintien cable, nylon, L=150mm NOIR   |   | 3 | ALL BIKES 1220  |
| 55 | YC110-01-05-WH | Cable tie L=350mm WHITE  | collier maintien cable L=350mm BLANC  |   | 1 | ALL BIKES 1220  |
| 56 | YC110-0109-23  | Clutch Cable Assy. L=920mm A+B=75mm  | cable embrayage L=920mm A+B=75mm  |  | 1 | SP21321   |

### Steering stem assembly



| N° | Ref.             | Description   | Français  | Picture   | Qty/Bike | Model   |
|----|------------------|---|---|---|----------|---|
| 25 | YC110-02-053-BK  | Complete Triple Clamp (TOPd45mm / BOTTOM d48mm) adjustable bar mount, CP 2020 Type BLACK  | Te Fourche Complet (TE SUPd45mm / TE INF d48mm) pontet ajustable Type CP 2020 NOIR  |  | 1        | W88E20/S88SE21/S12521/S125SE21/SM12520/SM15021/SP221/B12520/B15021/BFZ19021   |
| 1  | YC110-0201-03    | Steering stem L=233mm   | tige colonne direction L=233mm  |  | 1        | S12521/S12551119/S1255E1521/P1251120/P1501120/SM1251220/SM1501320/SP11317/SP21321/SP31321/B1251721/B1501721/BF01901721/BFZ1901821/S1471821/S1871821 |
| 3  | YC110-0201-56-BK | Top Triple Clamp L=160mm d45mm H=28mm 2022 MATT BLACK, 3 ADJUSTABLE POSITIONS   | té fourche supérieur L=160mm d45mm H=28mm 2022 NOIR MAT, REGLAGE 3 POSITIONS  |  | 1        | W88E21/S88SE21/S12521/S125SE21/SM12521/SM15021/SP221/B12521/B15021/BF15020/BFZ19020   |
| 2  | YC110-0202-56-BK | Lower triple clamp L=160mm d48mm H=28mm 2020 MATT BLACK   | té fourche inferieur L=160mm d48mm H=28mm 2020 NOIR MAT   |  | 1        | W88E20/S88SE21/S12521/S125SE21/SM12520/SM15021/SP221/B12520/B15021/BFZ19021   |
| 26 | YC110-0203-035   | Set of Bar mount d22.2mm/bottom 55mm START Type BLACK (with GB70-M10x50x1.5W 2EA+BT08-M8x30-W 4EA) Set of Bar mount d22.2mm/bottom 55mm START Type BLACK (with GB70-M10x50x1.5W 2EA+BT08-M8x30-W 4EA) | jeu pontet guidon d 22.2mm / pontet bas 55mm Type START NOIR (with GB70-M10x50x1.5W 2EA+BT08-M8x30-W 4EA) jeu pontet guidon d 22.2mm / pontet bas 55mm Type START NOIR (with GB70-M10x50x1.5W 2EA+BT08-M8x30-W 4EA) |  | 1        | W88E20/L8821/S88SE21/L12521/S12521/S125SE21/P12521/P15021/SM12520/SM15021/SP221/B12520/B15021/BFZ19021  |

|    |                  |  |  |   |   |  |
|----|------------------|--|--|---|---|--|
| 5  | YC110-0203-32    | 2020 Lower Bar Mount CNC START type, not adjustable d22.2mm H=55mm BLACK           | Pontet guidon inférieur type START d22.2mm H=55 mm NOIR 2020                   |     | 2 | W88E20/L8821/S88SE21/L12521/S12521/S125SE21/P12521/P15021/SM12520/SM15021/SP221/B12520/B15021/BFZ19021   |
| 4  | YC110-0201-02    | 2020 Top Bar Mout CNC d22.2 mm H=18mm START Type BLACK                             | pontet guidon supérieur 2020 d22.2mm H=18mm Type START NOIR                    |    | 2 | W88E20/L8821/S88SE21/L12521/S12521/S125SE21/P12521/P15021/SM12520/SM15021/SP221/B12520/B15021/BFZ19021   |
| 15 | BT08-M6x25-W     | HEXAGON Torx screw with Flange M6x25mm   | Vis HEXAGONALE Torx avec Flange M6x25mm  |    | 8 | ALL BIKES 21   |
| 17 | BT08-M8x30-W     | HEXAGON Torx screw with Flange M8x30mm   | Vis HEXAGONALE Torx avec Flange M8x30mm  |    | 4 | W88E20/S88SE21/L8821/L12521/S12521/S125SE21/P12521/P15021/SM12520/SM15021/SP221/SP321/B12520/B15021/BFD19020/BFZ19021  |
| 14 | GB70-M10x50x1.5W | HEXAGON SOCKET Head Bolt with half thread M10x50mmx1.5mm                           | Vis Allen (BTR) avec deport M10x50mmx1.5mm                                     |    | 2 | W88E20/S88SE21/L8821/L12521/S12521/S125SE21/P12521/P15021/SM12520/SM15021/SP221/B12520/B15021/BFZ19021   |
| 6  | YC110-0212-07-WH | Front Number Plate complete 2014 WHITE   | PLAQUE AVANT complete 2014 BLANC   |    | 1 | W88E20/S88SE21/L8821/L1251720/S12521/S125S1419/S125SE1420/P1251420/P1501420/SM125S1420/SM1501420/SP11417/SP21421/SP31421   |
| 20 | BT08-M6x12-W     | HEXAGON Torx screw with Flange M6x12mm   | Vis HEXAGONALE Torx avec Flange M6x12mm  |    | 1 | ALL BIKES 21   |
|    | GB97-d6-W        | Flat washer d6mm   | Rondelle plate d6mm  |    | 1 | ALL BIKES2020  |
| 27 | KRDIRECTION46    | set of bearing for steering 46/23.5、46/22set of bearing for steering 46/23.5、46/22 | Kit rit colonne direction 46/23.5、46/22Kit rit colonne direction 46/23.5、46/22 |    | 1 | 50A20/50E20/W88E20/S88SE21/L8821/L12521/125S1519/S125SE1521/P1251321/P1501320/SM125S1320/SM1501320/SP11117/SP21221/SP31220/B1251721/B1501721/BF1501720/BFD1901721/BFZ1901721/S1471821/S1871821 |
| 9  | YC110-02-09      | Top nut for steering d54.5mm   | écrou crantellé colonne direction d54.5mm                                      |    | 1 | ALL BIKES 1220   |
| 10 | YC110-02-10      | Washer for steering stem nut d22mmxd37mmx0.7mm                                     | joint colonne direction d22mmxd37mmx0.7mm                                      |   | 2 | ALL BIKES 1220   |
| 11 | YC110-02-11      | Nut for steering stem M11  | écrou supérieur colnne direction M11   |  | 1 | ALL BIKES 1220   |
| 13 | YC110-0214-01-WH | Complete Break Line Retainer White (with GB9074.5-M4x10-W 1EA )                    | guide durite avec vis sur plaque avant complet Blanc                           |  | 1 | 50A20/50E20/W88E20/S88SE21/L8821/L1251621/S125SE1521/P1251420/P1501420/SM125S1420/SM1501420/S11417/SP21421/SP31421/B1251721/B1501721/BF1501721/BFD1901721/BFZ1901721                           |
|    | YC110-0213-12    | Front plastic plate to hold cables 75mmx80mm                                       | Plaque avant plastique maintien cables 75mmx80mm                               |  | 1 | ALL BIKES 21   |
| 30 | YC110-0213-08    | Number plate bracket   | support plaque avant   |  | 1 | S1251420/S125SE1521/P1251420/P1501420/SM1251620/SM1501621/SP11617/SP21621/SP31621/B1251721/B1501721/BF1501721/BFD1902E1720/BIGVF190D1720   |
| 31 | GBT5787-M6x16-6  | Hex. Bolt with flanged M6x16mm (offset 6mm)  | vis M6x16mm (deport 6mm)   |  | 1 | ALL BIKES 21   |
|    | YC110-01-08-BK   | Cable tie, PA66 L=80mm ADJUSTABLE BLACK  | Collier maintien cable,PA66 L=80mm AJUSTABLE NOIR                              |  | 2 | S1251420/S125SE1521/P1251420/P1501420/SM1251620/SM1501621/SP11617/SP21621/SP31621/B1251721/B1501721/BF1501721/BFD1902E1720/BIGVF190D1720   |
|    | YC110-02-20      | Washer for steering stem nut   | joint colonne direction  |  |   | S1251420/S125S1419/S125SE1420/P1251421/P1501421/SM1251420/SM1501420/SP11417/SP21420/SP31421/B1251721/B1501721/BF1501721/BFD1901721/BFZ1901821/S1471821/S1871821/S88SE21                        |

Front Fender

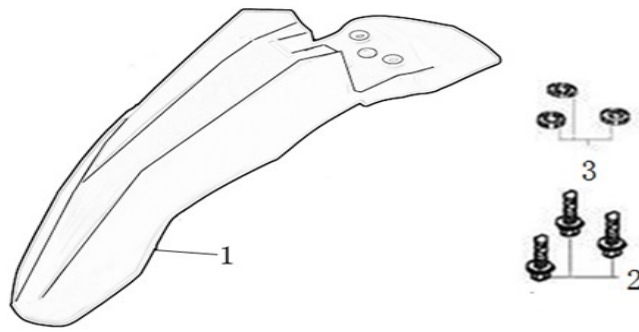



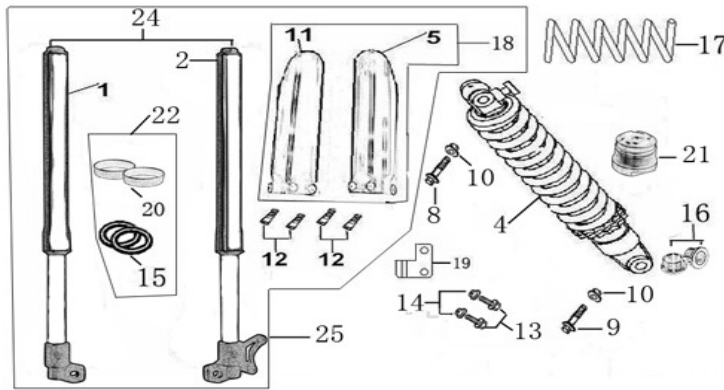

| N° | Ref.            | Description  | Français   | Picture | Qty/Bike | Model  |
|----|-----------------|--|--|---------|----------|--|
| 1  | YC110-032-02-WH | YCF Front Fender 2020 (Short) WHITE                    | GARDE BOUE AVANT 2020 Court BLANC                |         | 1        | W88E20/S88SE21/L12521/S125SE21/S12521/P12521/P15021/SM12520/S15021/SP221/SP321   |
| 2  | GBT5787-M6x16-6 | Hex. Bolt with flanged M6x16mm (offset 6mm)            | vis M6x16mm (deport 6mm)                         |         | 3        | 50A20/50E20/W88E1821/S88SE1820/L8821/L12521/S12521/S125SE1820/P1251821/P1501821/SM1251820/SM1501821/SP21821/SP31820/B1251821/B1501821/BF1501721/BFD19017820/BFZ1901821 |
|    | GBT5787-M6x16-3 | HEXAGON screw with Flange with half thread M6x16mmx3mm | Vis HEXAGONALE avec Flange et deport M6x16mmx3mm |         | 2        | 50A20/50E20/W88E1821/S88SE1820/L8821/L12521/S12521/S125SE1820/P1251821/P1501821/SM1251820/SM1501821/SP21821/SP31820/B1251821/B1501821/BF1501721/BFD19017820/BFZ1901821 |

#### Front & Rear absorber









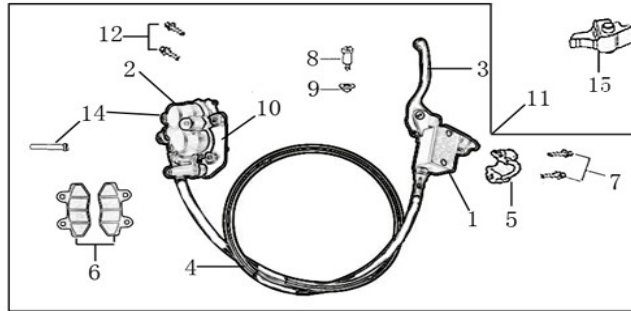



| N° | Ref.            | Description  | Français  | Picture | Qty/Bike | Model   |
|----|-----------------|--|---|---------|----------|---|
| 24 | YC110-0400-10   | Pair of forks L=735mm ZL (Compression adjustable) GREY         | Jeu de fourches L=735mm ZL (compression réglable) GRIS        |         | 1        | SP11317/SP21321   |
| 1  | YC110-0401-09   | Front right fork ZL L=735mm (Compression adjustable) GREY 2013 | Tube fourche droit L=735mm GRIS (compression réglable) 2013   |         | 1        | SP11317/SP21321   |
| 2  | YC110-0402-09   | Front left fork ZL L=735mm (Compression adjustable) GREY 2013  | Tube fourche gauche L=735mm GRIS (compression réglable) 2013  |         | 1        | SP11317/SP21321   |
|    | BT08-M6x30-W    | HEXAGON Torx screw with Flange M6x30mm                         | Vis HEXAGONALE Torx avec Flange M6x30mm                       |         | 2        | All Bikes20   |
|    | GB93-d6-W       | Spring Lock Washers d6mm                                       | Rondelle a ressort d6   |         | 4        | SP31621/BF1501721/BFZ1901821/BFD19020   |
| 4  | YC110-0404-16   | Shock absorber ZL 330mmx640lbs YELLOW                          | Amortisseur ZL 330mmx640lbs JAUNE                             |         | 1        | SP11317/SP21321   |
| 16 | YC110-0419-03   | Shock bottom spacer ENGI d12mmxd14mmx6x11mm                    | Entretoise amortisseur pour bras mono ENGI d12mmxd14mmx6x11mm |         | 4        | SP11617/SP21621/SP31621/BIGYF150Mx1720/BIGYFD200Mx1721/BIGY200ZE21  |
| 18 | PFYCF12-BK      | YCF 735 set of fork protection L=285mm 2012 black              | Jeu protection fourche YCF 735 noir L=285mm                   |         | 1        | P1251622/P1501622/SM1501622/SP11617/SP22620/S1501620/B1251720/B1501720/BF1501719/BFD1901720/BFZ1901720  |
| 8  | GB5789-M12x45-W | HEXAGON screw with Flange M12x45mm                             | Vis HEXAGONALE avec Flange M12x45mm                           |         | 1        | W88E1821/S88SE1420/L8821/L1251621/125S1519/S125SE1521/P1251420/P1501420/SM1251420/SM1501420/SP11420/SP21421/SP31421/B1251721/B1501721/BF1501721/BFD1901721/BFZ1901721/S1471821/S1871821 |

|    |                 |   |  |   |   |  |
|----|-----------------|---|--|---|---|--|
| 9  | GB5789-M12x60-W | HEXAGON screw with Flange M12x60mm                  | Vis HEXAGONALE avec Flange M12x60mm            |   | 1 | SP1319/SP21321/SP31421/BF1501720/BFD1901721/BFZ1901821   |
| 10 | GB6187-M12-W    | HEXAGON FLAT FLANGE LOCK NUT M12mm                  | Ecrou HEXAGONAL avec Flange autobloquant M12mm |  | 2 | W88E1821/S88E1420/L8821/L1251621/12551519/S1255E1521/P1251420/P1501420/SM1251420/SM1501420/SP11420/SP21421/SP31421/B1251721/B1501721/BF1501721/BFD1901721/BFZ1901721/S1471821/S1871821 |
| 12 | GBT5787-M6x14-5 | Screw with flange M6x14mm (spacer 5 mm)             | Vis avec epaulement M6x14mm (deport 5 mm )     |  | 6 | W88E1821/S88E1820/S12521/S1255E1820/P1251821/P1501821/SM1251820/SM1501821/SP21821/SP31820/B1251821/B1501821/BF1501721/BFD1901821/BFZ1901821  |
|    | YC110-0403-05   | Complete Oil steel line retainer on left front fork | Passe durite sur protection fourche gauche     |  | 1 | W88E20/S88E21/L8821/L12521/S1255E21/P12521/P15021/SM12520/SM15021/SP221/SP321/B12520/B15021/BFD19020/BFZ19021/S14720/S18721  |

### Front Brake Assy









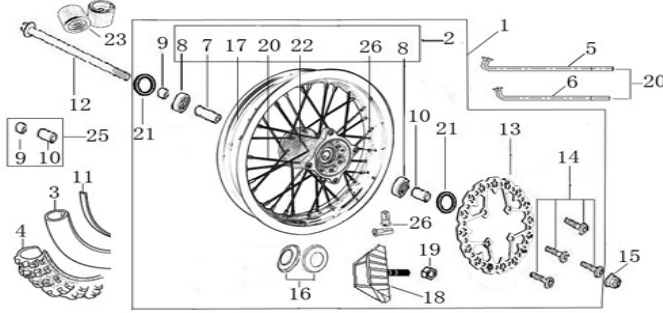

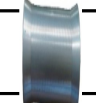

| N° | Ref.               | Description  | Français  | Picture   | Qty/Bike | Model   |
|----|--------------------|--|---|---|----------|---|
| 11 | YC110-0501-2101    | Front brake assy 2 pumps L=1110mm d10mm/d10mm w/t asbestos           | Kit frein avant 2 pistons avec gaine plastic noire L=1110mm d10/10 sans amiante |  | 1        | SP221   |
| 1  | YC110-0501-0104-03 | Front Brake Reservoir for 2 pump piston d12mm 2020                   | Maitre cylindre frein avant pour étrier 2 pistons piston d12mm 2020             |  | 1        | P12521/P15021/SM15021/SP221/SP321/B12520/B15021/BF15020/BFD19020/BFZ19021   |
| 2  | YC110-0501-0207    | Front Brake caliper for 2 pump w/t abestos d 10                      | étrier frein avant double pistons sans amiante d10                              |  | 1        | SP21621/SP31621/BF1501721/BFD1901721/BFZ1901821   |
| 3  | YC110-0517-01      | Front brake lever for 2 pump brake adjustable                        | levier frein ajustable  |  | 1        | ALL BIKES 1920  |
| 4  | YC110-0501-0326    | Front brake steel line L=1110mm d10mm/d10mm BLACK 2020               | Durite frein avant L=1110mm d10mm/d10mm NOIR 2020                               |  | 1        | P1251621/P1501621/SM1501621/SP21621   |
| 7  | BT08-M6x20-W       | HEXAGON Torx screw with Flange M6x20mm                               | Vis HEXAGONALE Torx avec Flange M6x20mm   |  | 2        | ALL BIKES 21  |
| 6  | YC110-0501-0416    | Front Brake pads for double pump brake with copper substrate         | jeu plaquette frein avant pour frein 2 pistons SANS AMIANTE                     |  | 2        | SP21621/SP31621/BF1501721/BFD1901721/BFZ1901821   |
| 8  | HB06-M6x25-G       | Hex.bolt with flanged M6x25mm (Step M8x15mm) front front brake lever | vis M6x25mm pour levier frein avant   |  | 1        | W88E1821/S88E1521/S12521/S12551419/S1255E1521/P1251420/P1501420/SM1251420/SM1501420/SP11417/SP21421/SP31421/B1251721/B1501721/BFD1901721/BFZ1901721 |
| 9  | GB6177-M6-G        | HEXAGON FLAT FLANGE NUT M6   | Ecrou HEXAGONAL avec Flange M6  |  | 1        | W88E1821/S88E1521/S12521/S12551419/S1255E1521/P1251420/P1501420/SM1251420/SM1501420/SP11417/SP21421/SP31421/B1251721/B1501721/BFD1901721/BFZ1901721 |
| 10 | YC110-0501-037     | Bracket for front brake SP2/SP3                                      | Patte frein avant etrier SP2/SP3  |  | 1        | SP21621/SP31621/BF1501721/BFD1901721/BFZ1901821   |

|    |               |  |   |   |   |  |
|----|---------------|--|---|---|---|--|
| 12 | BT08-M6x35-W  | HEXAGON Torx screw with Flange M6x35mm | Vis HEXAGONALE Torx avec Flange M6x35mm |   | 2 | W88E20/S88E21/L8821/L12521/S12521/S1255E21/P12521/P15021/SM12520/SM15021/SP221/SP321/B12520/B15021/BFD19020/BFZ19021 |
| 14 | YC110-0555-01 | caliper screw for front brake L=55mm   | Vis plaquette frein avant L=55mm        |  | 1 | SP21621/SP31621/BF1501721/BFD1901721/BFZ1901821  |
| 15 | YC110-0515-01 | rubber for brake lever                 | caoutchouc levier frein avant           |  | 1 | W88E1821/S88E1420/P1251420/P1501420/SM1251420/SM1501420/SP21421/SP31421/B1251721/B1501721/BFD1901721/BFZ1901821      |

### Front Wheel Assy





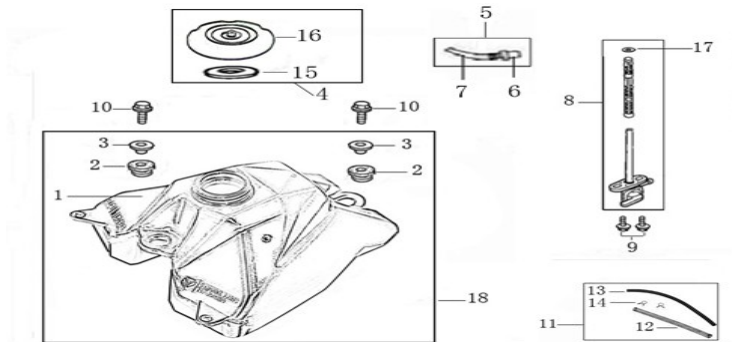

| N° | Ref.             | Description   | Français   | Picture   | Qty/Bike | Model   |
|----|------------------|---|--|---|----------|---|
| 1  | YC110-0601-22-BK | Complete ALUMINIUM Front wheel 1.4x 14' with disk CNC hub BLACK / BLACK Rim 2021 (SPOKES 4 mm - 8K) | Roue avant complète ALUMINIUM 1.4x14' avec disque moyeux CNC NOIR / Jante NOIRE 2021 (RAYONS 4 mm -8K) |    | 1        | SP223   |
| 3  | CHAMBRE14        | Tube for front tire 60/100-14' JUNXI  | Chambre a air avant 60/100-14 JUN XI   |   | 1        | L1251621/S1251220/S125S1219/S125S1521/P1251321/P1501320/SP1321/SP21321/SP31321  |
| 4  | 60/100/14ARRO    | Front tyre 60/100/14 ARRO 2015  | pneu avant 60/100/14 ARRO 2015   |  | 1        | SP21521/SP31521   |
| 22 | YC110-0622-22-BK | YCF Front hub CNC BLACK 2020 (SPOKES 4 mm - 8K)   | YCF Moyeux avant CNC NOIR 2020 (RAYONS 4 mm -8K)   |  | 1        | SP221/SP321/BFD19021/BFZ19021   |
| 7  | YC110-0607-03    | Front axle bushing d17mmxd22mmx46mm   | Entretoise central roue avant d17mmxd22mmx46mm   |  | 1        | SP21621/SP31621/BF1501721/BFD1901721/BFZ1901821   |
| 8  | 6003             | NTN Ball bearing 6003 35mmxd17mmx10mm   | Roulement roue 6003 NTNd35mmxd17mmx10mm  |  | 2        | SP21621/SP31621/BF1501721/BFD1901721/BFZ1901821   |
| 21 | YC110-0611       | OIL SEAL d23mmxd35mmx5mm  | joint spy roue d23mmxd35mmx5mm   |  | 2        | W88E1821/L881721/S88E1521/L1251621/S125S1019/S125S1521/S12521/P1251321/P1501020/SM1251021/SM1501020/SP11017/SP21020/SP31421/B1251721/B1501721/BF1501721/BFD1901721/BFZ1901821/S1471821/S1871821 |
| 9  | YC110-06-048     | Front wheel spacer right d15mmxd22mmx37.5mm with STEP d15mmxd17mmx14mm And d15mmx19.4mmx4mm Black   | Entretoise roue avant droite d15mmxd22mmx37.5mm STEP d15mmxd17mmx14mm And d15mmx19.4mmx4mm Noir        |  | 1        | SP21621/BFD1901721/BFZ1901821   |
| 10 | YC110-06-056     | Front wheel spacer left d15mmxd22mmx47mm with STEP d15mmxd17mmx14mm Black                           | Entretoise roue avant gauche d15mmxd22mmx47mm with d15mmxd17mmx14mm Noir                               |  | 1        | SP21621/BFD1901721/BFZ1901821   |
| 11 | YC110-06-01      | tire lining for 1.4x14'   | fond jante av 1.4x14'  |  | 1        | L1251621/S12521/S125S1219/S125S1521/P1251321/P1501320/SP11217/SP21221/SP31220   |
| 12 | YC110-06-061     | Front Axle d15mm L=215 mm with Self-locking nut M14   | axe de roue avant d15mm L=215 mm avec ecrou M14  |  | 1        | W88E1821/S88E1521/S125S1519/S12521/S125S1521/P1251420/P1501420/SP11417/SP21421/B1251721/B1501721/BF1501721/BFD1901721/BFZ1901821  |

|    |                  |   |  |   |   |  |
|----|------------------|---|--|---|---|--|
| 15 | GB6187-M14-W     | HEXAGON FLAT FLANGE LOCK NUT M14                    | Ecrou HEXAGONAL avec Flange autobloquant M14     |   | 1 | W88E20/S88SE21/L881721/L1251621/S125S1619/S1251620/S125SE1620/P1251621/SP1501621/SP11617/SP21621/SM1251620/SM1501621/B1251721/B1501721/BFD1901721/BFZ1901821         |
| 13 | YC110-0513-02    | Brake disk front d220mm                             | Disque frein avant d220mm                        |  | 1 | W88E20/S88SE21/L1251621/S125S1619/S1251620/S125SE1620/P1251621/SP1501621/SP11617/SP21621/SM1251620/SM1501621/B1251721/B1501721/BFD1901721/BFZ1901821                 |
|    | KVD              | Disk screws kit (contain GB70.2-M8x16-Cr 4EA)       | KIT VIS DISQUE M8x16 (lot 4)                     |  | 1 | W88E20/S88SE21/L881721/L1251621/S125S1619/S12521/S125SE1620/P1251621/SP1501621/SP11617/SP21621/SM1251620/SM1501621/B1251721/B1501721/BFD1901721/BFZ1901821/BF1501721 |
| 17 | YC110-0617-22-BK | ALUMINIUM Rim for Front wheel 2.50x14' Black        | cerceau roue av 2.50x14' ALUMIUM Noir            |  | 1 | SP223/SP323  |
| 20 | JR14-15.0-8K     | set of front spoke 14' (147mmx16+150mmx16)8K(4.0mm) | Jeu rayon avant 14' (147mmx16+150mmx16)8K(4.0mm) |  | 1 | SP221/SP321  |
| 18 | GRIPSTERAV-R     | Reinforced gripster - 1.40                          | Gripster renforce - 1.40                         |  | 1 | SP1217/SP21221/SP31220/BF1501721/BFD1901721/BFZ1901821   |

### Fuel Tank



| N° | Ref.                 | Description   | Français   | Picture   | Qty/Bike | Model  |
|----|----------------------|---|--|---|----------|--|
| 1  | YC110-0701-02        | YCF Complete fuel tank suitable for pre bikes (with YC110-07-01 2EA+YC110-07-02 2EA+YC110-1910 1EA) | Reservoir complet YCF (Adaptable pour motos avant) |  | 1        | W88E1821/S88SE1320/S88S1316/L881721/L1251621/S12521/S125S1319/S125SE1521/P1251321/P1501320/SM1251320/SM1501320/SP11317/SP21321/SP31421 |
| 4  | YC110-0702-01        | YCF Tank cap plastic Ventilator d3mm  | Bouchon reservoir plastique YCF d3mm               |  | 1        | ALL BIKES 1121   |
| 15 | YC110-0720-02        | Rubber mat for tank cap plastic d14mmxd52mmx2mm Oil proof   | Caoutchouc bouchon reservoir YCF d14mmxd52mmx2mm   |  | 1        | ALL BIKES 1321   |
| 5  | YC125-0704-BK L=40mm | Fuel tank valve BLACK L=40mm  | Valve prise air NOIR L=40mm                        |  | 1        | ALL BIKES  |
| 8  | YC110-0703           | Fuel cock assy.   | robinet essence                                    |  | 1        | ALL BIKES  |
| 9  | BT08-M6x16-W         | HEXAGON Torx screw with Flange M6x16mm  | Vis HEXAGONALE Torx avec Flange M6x16mm            |  | 2        | ALL BIKES 21   |
| 16 | BT08-M8x30-W         | HEXAGON Torx screw with Flange M8x30mm  | Vis HEXAGONALE Torx avec Flange M8x30mm            |  | 2        | SP117/SP21720/SP31720/BIGY1720/FT14720/FT18720   |
| 11 | YC110-0706           | fuel tank rubber line spring d4.5mmxd8.5mmx210mm  | durite reservoir avec ressort d4.5mmxd8.5mmx210mm  |  | 1        | ALL BIKES  |

### Air Filter

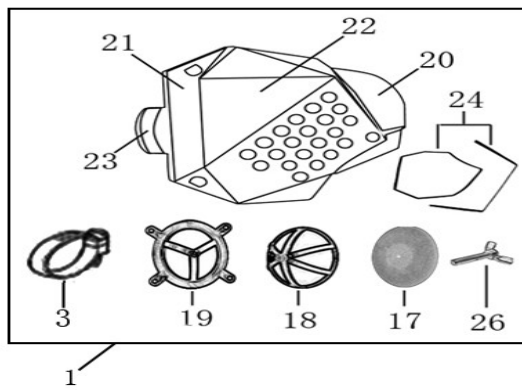





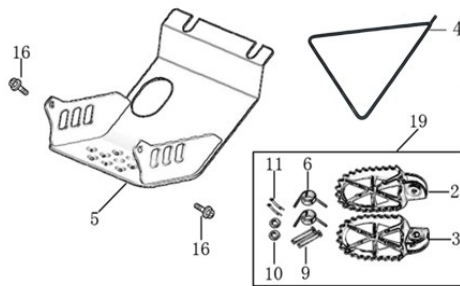

| N° | Ref.           | Description  | Français  | Picture | Qty/Bike | Model   |
|----|----------------|--|---|---------|----------|---|
| 1  | YC110-08-05    | Air box assy with YCF LOGO 2021 for NIBBI carburetor d45 B150/SP2                                  | Boite a air complete YCF 2021 pour carburateur NIBBI d45 B150/SP2       |         | 1        | B15021/BF15021/SP221  |
| 3  | YC110-0805     | Holding ring d27mm-d51mm   | collier Filtre d27mm-d51mm  |         | 1        | SP11317/SP21321/SP31321/B1251721/B1501721/BF1501721/BFD2101721/BFZ2101821   |
| 17 | YC110-0817-03  | YCF Air filter Foam DOUBLE THICKNESS BLUE  | Mousse filtre a air YCF DOUBLE EPAISSEUR BLEU                           |         | 1        | SP11317/SP21321/SP31321/B1251721/B1501721/BF1501721/BFD2101721/BFZ2101821   |
| 18 | YC110-08-012   | Top support for YCF air filter foam  | support exterieur pour mousse filtre a air YCF                          |         | 1        | SP11317/SP21321/SP31321/B1251721/B1501721/BF1501721/BFD2101721/BFZ2101821   |
| 19 | YC110-08-01301 | Inside support for YCF air filter foam   | support interieur pour mousse filtre a air YCF                          |         | 1        | SP11317/SP21321/SP31321/B1251721/B1501721/BF1501721/BFD2101721/BFZ2101821   |
|    | GB70.2-M5x12   | Plus screw M5x12mm   | vis M5x12mm support interieur   |         | 4        | SP11317/SP21321/SP31321/B1251721/B1501721/BF1501721/BFD2101721/BFZ2101821   |
| 26 | GB62-M6x30-W   | Butterfly screw M6x30mm for top support  | vis M6x30mm pour fixation support exterieur                             |         | 1        | SP11317/SP21321/SP31321/B1251721/B1501721/BF1501721/BFD2101721/BFZ2101821   |
| 36 | GB93-d6        | Spring Lock Washers d6mm   | Rondelle a ressort d6mm   |         | 1        | SP11317/SP21321/SP31321/B1251721/B1501721/BF1501721/BFD2101721/BFZ2101821   |
| 18 | GB97-d6-W      | Flat washer d6mm   | Rondelle plate d6mm   |         | 1        | ALL BIKES 2112-2020   |
| 23 | YC110-0823-03  | Rubber link between air box and carb for YCF air box for NIBBI carburetor d45 2021 (B150/SP2 logo) | Manchon boite a air YCF pour carburateur NIBBI d45 2021 (B150/SP2 logo) |         | 1        | SP11221/SP21221/B1252121/B15021/BF15021/BFZ21021  |
|    | GB70-M4x20     | HEXAGON SOCKET Head Bolt M4x20mm   | Vis Allen (BTR) M4x20mm   |         | 3        | P1251821/P1501821/SM1501821/SP21821/SP31820/B1251821/B1501821/BF1501721/BFD1901821/BFZ1901821/S1471821/S1871821         |
|    | GB70-M5x20     | HEXAGON SOCKET Head Bolt M5x20mm   | Vis Allen (BTR) M5x20mm   |         | 4        | P1251821/P1501821/SM1501821/SP21821/SP31820/B1251821/B1501821/BF1501721/BFD1901821/BFZ1901821/S1471821/S1871821         |
| 25 | YC110-0825-02  | Support of Air box BLACK SP  | Support Boite a air acier NOIR  |         | 1        | B1251721/B1501721/BF1501721/BFD1901721/BFZ1901821   |
|    | GB70.2-M6x16   | Pan head hexagon screw M6x16mm   | Vis à tête ronde Allen (BTR) M6x16mm                                    |         | 2        | B1251721/B1501721/BF1501721/BFD1901721/BFZ1901821   |
|    | GB97-d6-W      | Flat washer d6mm   | Rondelle plate d6mm   |         | 2        | ALL BIKES 2112-2021   |
|    | GB6189-M6-W    | Cltch Self-lock Nut M6 for air box support   | ecrou M6 pour Support Boite a air                                       |         | 2        | P1251321/P1501621/SM1501621/SP11317/SP21821/SP31820/B1251721/B1501721/BF1501721/BFD1901721/BFZ1901821/S1471821/S1871821 |
|    | PE24SP         | NIBBI Carburetor PE24SP  | NIBBI Carburetor PE24SP   |         | 1        | L12521/S12521/S125S21/S125SE21/P12521/P15021/SP121/SP221/B15021/BF15021/SUNDAY14721                                     |

|                |  |   |   |   |   |
|----------------|--|---|---|---|---|
| LK-PE-112      | Main Jet Nibbi #112                    | Gicleur principal Nibbi #112            |   | 1 | L12521/S12521/S125521/S1255E21/P12521/P15021//SP121/SP221/B15021/BF15021/SUNDAY14721  |
| LK-FLK-40      | Slow Jet Nibbi #40                     | Gicleur ralenti Nibbi #40               |  | 1 | L12521/S12521/S125521/S1255E21/P12521/P15021//SP121/SP221/B15021/BF15021/SUNDAY14721  |
| BT08-M6x35-W   | HEXAGON Torx screw with Flange M6x35mm | Vis HEXAGONALE Torx avec Flange M6x35mm |  | 2 | ALL BIKES 21  |
| GB6170-M6-W    | Nut M6                                 | Ecrou M6                                |  | 2 | ALL BIKES 1121  |
| 17311-2-01     | Inlet Pipe,Pro 2021                    | PIPE ADMISSION 2021                     |  | 1 | P15021/SP221  |
| BT08-M6x20-W   | HEXAGON Torx screw with Flange M6x20mm | Vis HEXAGONALE Torx avec Flange M6x20mm |  | 2 | ALL BIKES 21  |
| 17332          | carburettor paper gasket d28mm         | joint papier carburateur d28mm          |  | 1 | S885E1521/L881721/L1251621/S12551319/S1255E1521/S12521/P1251321/P1501320/SM1251320/SM1501320/SP11317/SP21321/B1251721/B1501721/BF1501721/S1471821 |
| 17332/152FMH01 | Intake Gasket d=28mm                   | JT PAPIER PIPE ADMISSION d=28mm         |  | 1 | S885E1521/L881721/L1251621/S12551319/S1255E1521/S12521/P1251321/P1501320/SM1251320/SM1501320/SP11317/SP21321/B1251721/B1501721/BF1501721/S1471821 |
| F00C039        | carburettor isolating gasket d27.5mm   | joint plastique carburateur d27.5mm     |  | 1 | S885E1521/L881721/L1251621/S12551319/S1255E1521/S12521/P1251321/P1501320/SM1251320/SM1501320/SP11317/SP21321/B1251721/B1501721/BF1501721/S1471821 |

#### Foot Peg assy



| N° | Ref.          | Description   | Français  | Picture   | Qty/Bike | Model  |
|----|---------------|---|---|---|----------|--|
| 19 | YC110-0902/05 | Inox foot pegs set Large                              | Jeu repose pied inox Large                              |  | 1        | SP1321/SP21321/SP31421/BF1501721/BFD1901721/BF21901821   |
| 6  | YC110-0906    | Spring for inox foot peg (left/right) d2mmxd16mmx35mm | ressort repose pied (droit/gauche) inox d2mmxd16mmx35mm |  | 2        | SP1321/SP21321/SP31421/BF1501721/BFD1901721/BF21901821/S1471821/S1871821                                       |
| 9  | GB882-d8x45   | shaft pin for inox footpegs Stainless steel d8mmx45mm | axe repose pied inox d8mmx45mm                          |  | 2        | BIGY1902E21/BIGY190021/SP221/SP321/S14720/S18721   |
| 10 | GB97-d8-W     | Flat washer d8mmxd16mmx1mm                            | Rondelle plate d8mmxd16mmx1mm                           |  | 2        | ALL BIKES 1121   |
| 11 | GB91-d2x25-W  | Split pin 2.0x25mm                                    | Goupille 2.0x25mm                                       |  | 2        | ALL BIKES 1321   |
| 4  | YC110-190-01  | Side stand SP BLACK                                   | Triangle support SP NOIR                                |  | 1        | SP11520/SP21521/SP31521/S1471821/S1871821  |
| 5  | YC110-207-04  | Engine skid plate Steel SP/BIGY #2 T=3mm BLACK        | SABOT ACIER SP/BIGY #2 T=3mm NOIR                       |  | 1        | SP21421  |
| 16 | BT08-M6x16-W  | HEXAGON Torx screw with Flange M6x16mm                | Vis HEXAGONALE Torx avec Flange M6x16mm                 |  | 2        | S885E21/L8821/L12521/S12521/S1255E21/P12521/P15021/SM12520/SM15021/SP221/SP321/B12520/B15021/BFD19020/BF219021 |

|    |              |  |   |   |   |   |
|----|--------------|--|---|---|---|---|
| 10 | BT08-M8x25-W | HEXAGON Torx screw with Flange M8x25mm | Vis HEXAGONALE Torx avec Flange M8x25mm |    | 4 | ALL BIKES 21  |
| 22 | GB93-d8-W    | Spring Lock Washers d8mm               | Rondelle a ressort d8mm                 |  | 4 | SP11617/SP21621/SP31621/B1251721/B1501721/BF1501721/BFD1901721/BFZ1901821 |
| 10 | GB97-d8-W    | Flat washer d8mm                       | Rondelle plate d8mm                     |  | 4 | ALL BIKES 1121  |

### Swing Arm assy

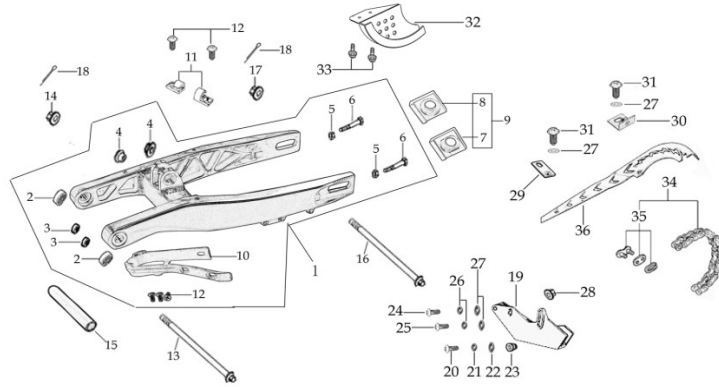







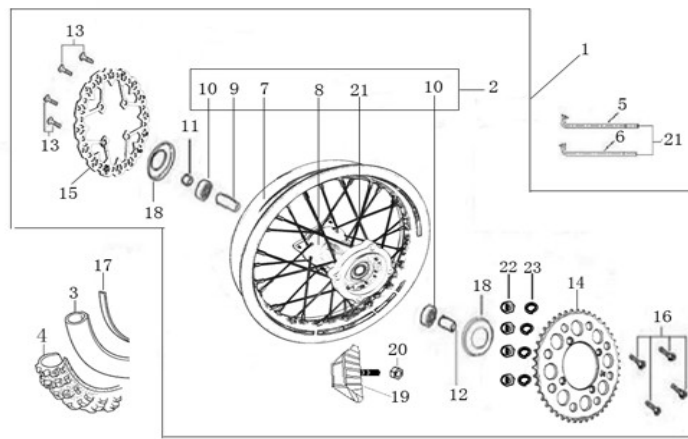







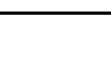

| N° | Ref.            | Description   | Français  | Picture   | Qty/Bike | Model  |
|----|-----------------|---|---|---|----------|--|
| 1  | YC110-10015-01  | Mono swing arm YCF Aluminium 420mm 2020 d12mm (174 mm)  | Bras oscillant mono YCF Aluminium 420mm 2020 d12mm (174 mm)   |    | 1        | SP221  |
| 2  | YC110-10-015-BK | Rear brake hose guide 2020  | Passe durite de frein arriere sur bras oscillant 2020   |    | 1        | ALL BIKES 21   |
| 12 | DIN7985-M6x16   | Screw M6x16mm   | Vis M8x16mm   |   | 5        | ALL BIKES 21   |
| 10 | YC110-10-025    | Chain slider YCF Aluminium swing arm 420mm PU   | Patin chaine PU YCF pour bras oscillent   |  | 1        | P1251520/P1501520/SM1501520/SP111217/SP21221/SP31220/B1251721/B1501721/BF1501721/BFD1901721/BFZ1901821/S1471821/S1871821   |
| 2  | 6001-NTN        | NTN 6001 Bearingfor swing arm d12mmx28mmx8mm  | Roulement bras oscillent NTN 6001 d12mmx28mmx8mm  |  | 4        | SP21821/SP31820  |
| 15 | YC110-1007-11   | Central spacer swing arm Aluminium SP d13mmx20mmx141mm<br>Central spacer swing arm Aluminium SP | Entretoise centrale de bras oscillent SP d13mmx20mmx141mm<br>Entretoise centrale de bras oscillent SP |  | 1        | SP221/SP321  |
| 13 | YC110-10-033    | Swing arm shaft L=236mm   | axe bras oscillant d3 L=236mm   |  | 1        | SP11417/SP21421/SP31421  |
| 14 | GB6187-M12-W    | HEXAGON FLAT FLANGE LOCK NUT M12mm  | Ecrou HEXAGONAL avec Flange autobloquant M12mm  |  | 1        | SP11417/SP21421/SP31421  |
| 16 | YC110-11-075    | Rear wheel axle L=230mm with Self locking nut M14   | axe roue arriere L=230mm avec ecrou M14   |  | 1        | SP21221/SP31220/BF1501721/BFD1901721/BFZ1901821  |
| 17 | GB6187-M14-W    | HEXAGON FLAT FLANGE LOCK NUT M14  | Ecrou HEXAGONAL avec Flange autobloquant M14  |  | 1        | W88E1821/S88E1521/L881721/L1251621/S12551019/S1255E1521/S12521/P1251321/P1501020/SM1251021/SM1501020/SP11017/SP21020/SP31421/B1251721/B1501721/BF1501721/BFD1901721/BFZ1901821/S1471821/S1871821 |
| 5  | GB5783-M8x40-W  | Hexagon Head Bolt with full therad M8 x40mm   | Vis a tete HEXAGONALE M8 x40mm  |  | 2        | W88E1821/S88E1521/S1255E1521/S12551219/S1251220/P1251321/P1501220/SM1251220/SM1501220/SP11219/SP21221/SP31421/B1251721/B1501721/BF1501721/BFD1901721/BFZ1901821/S1471821/S1871821                |
| 6  | FB6170-M8-W     | Hex. Nut M8   | ecrou tendeur chaine M8   |  | 2        | W88E1821/S88E1521/S1255E1521/S12551219/S1251220/P1251321/P1501220/SM1251220/SM1501220/SP11219/SP21221/SP31421/B1251721/B1501721/BF1501721/BFD1901721/BFZ1901821/S1471821/S1871821                |
| 9  | YC110-11-095-SI | Set of Block axle SPI/SPII/SPIII/BIGY F150Mx/FD190Mx SILVER                                     | Jeu tendeur chaine SPI/SPII/SPIII/BIGY F150Mx/FD190Mx SILVER  |  | 1        | SP21421/SP31421/BF1501720/BFD1901721/BFZ1901821  |
| 19 | YC110-1004      | YCF chain guide assy for High class range BLACK   | guide chaine YCF pour haut de gamme NOIR  |  | 1        | P1251520/P1501520/SM1501520/SP11117/SP21120/SP31120/B1251721/B1501721/BFD1901721/BFZ1901721/S1471821/S1871821  |

|    |                |  |   |   |   |   |
|----|----------------|--|---|---|---|---|
| 15 | GB70.2-M5x16   | Pan head hexagon screw M5x16mm                       | Vis à tête ronde Allen (BTR) M5x16mm  |     | 1 | P1251520/P1501520/SM1501520/SP11117/SP21120/SP31120/B1251721/B1501721/BF1501721/BFD1901721/BFZ1901721/S1471821/S1871821   |
| 20 | GB70-M6x30     | Stud screw M6x30mm for chain guide assy              | vis M6x30mm pour guide chaîne   |    | 2 | ALL BIKES 1220  |
| 21 | GB93-d5        | Spring Lock Washers d5mm                             | Rondelle a ressort d5mm   |    | 1 | P1251520/P1501520/SM1501520/SP11117/SP21120/SP31120/B1251721/B1501721/BF1501721/BFD1901721/BFZ1901721/S1471821/S1871821   |
| 22 | GB97-d5-W      | Flat washer d5mmx10mmx1mm                            | Rondelle plate d5mmx10mmx1mm  |    | 1 | P1251520/P1501520/SM1501520/SP11117/SP21120/SP31120/B1251721/B1501721/BF1501721/BFD1901721/BFZ1901721/S1471821/S1871821   |
| 21 | GB93-d6-W      | Spring Lock Washers d6mm                             | Rondelle a ressort d6   |    | 2 | ALL BIKES 1220  |
| 22 | GB97-d6-W      | Flat washer d6mm                                     | Rondelle plate d6mm   |    | 2 | ALL BIKES 1220  |
| 36 | GB6177-M6-W    | HEXAGON FLAT FLANGE NUT M6                           | Ecrou HEXAGONAL avec Flange M6  |    | 1 | P1251520/P1501520/SM1501520/SP11117/SP21120/SP31120/B1251721/B1501721/BF1501721/BFD1901721/BFZ1901721/S1471821/S1871821   |
| 34 | 420Dx-108T-x   | Chain 420Dx-108T extra strong                        | Chaîne420-108T maillons renforcée   |    | 1 | SP11317/SP21321   |
| 35 | AR-420         | Chain link H=17mm                                    | Attache rapide chaîne H=17mm  |    | 1 | 50A1220/S88SE1420/L881320/L1251320/S125SE1521/S1251320/P1251420/P1501420/SM1251320/SM1501320/SP11317/B1251721/B1501721/S1471821                                       |
| 28 | YC110-1028-02  | Chain box protection                                 | Protection chaîne plastique   |   | 1 | W88E1920/L881920/S88SE1920/L1251920/S125SE1920/S12521/P1251920/P1501920/SM1251920/SM1501920/SP21920/SP31920/B1251920/B1501920/BFD1901920/BFZ1901920/S1471920/S1871920 |
|    | SC17-M8x20-B   | Rivet Plastic Black M8x20mm for Chain box protection | Rivet plastique M8x20 pour fixation de la Protection chaîne plastique M8x20mm |  | 2 | W88E1920/L881920/S88SE1920/L1251920/S125SE1920/S12521/P1251920/P1501920/SM1251920/SM1501920/SP21920/SP31920/B1251920/B1501920/BFD1901920/BFZ1901920/S1471920/S1871920 |
|    | BT08-M6x10-W   | HEXAGON Torx screw with Flange M6x10mm               | Vis HEXAGONALE Torx avec Flange M6x10mm                                       |  | 1 | ALL BIKES 21  |
|    | BT08-M6x16-W   | HEXAGON Torx screw with Flange M6x16mm               | Vis HEXAGONALE Torx avec Flange M6x16mm                                       |  | 1 | ALL BIKES 21  |
|    | GB97-d6-W      | flat washer d6mm for Chain box protection            | rondelle d6mm pour protection chaîne plastique                                |  | 2 | W88E1920/L881920/S88SE1920/L1251920/S125SE1920/S12521/P1251920/P1501920/SM1251920/SM1501920/SP21920/SP31920/B1251920/B1501920/BFD1901920/BFZ1901920/S1471920/S1871920 |
|    | YC110-1010     | YCF rear disk protection BLACK                       | Protection de disque arrière YCF NOIR   |  | 1 | SP1217/SP21221/B1251721/B1501721/BF1501721/BFZ1901821   |
| 33 | BT08-M6x12-W   | HEXAGON Torx screw with Flange M6x12mm               | Vis HEXAGONALE Torx avec Flange M6x12mm                                       |  | 2 | SP1217/SP21221/SP31220/B1251721/B1501721/BF1501721/BFD1901721/BFZ1901821  |
| 4  | YC110-1001-021 | Sleeve for swing arm d12mmx16mmx24mmx10mm            | Entretoise bras oscillant/amorto d12mmx16mmx24mmx10mm                         |  | 2 | SP11217/SP21221/SP31220/BF1501721/BFD1901721/BFZ1901821   |
| 18 | GB91-d2x35-W   | Split pin d2x35mm                                    | Goupille d2x35mm  |  | 2 | SP11217/SP21221/SP31220/BF1501721/BFD1901721/BFZ1901821   |

Rear Wheel Assy









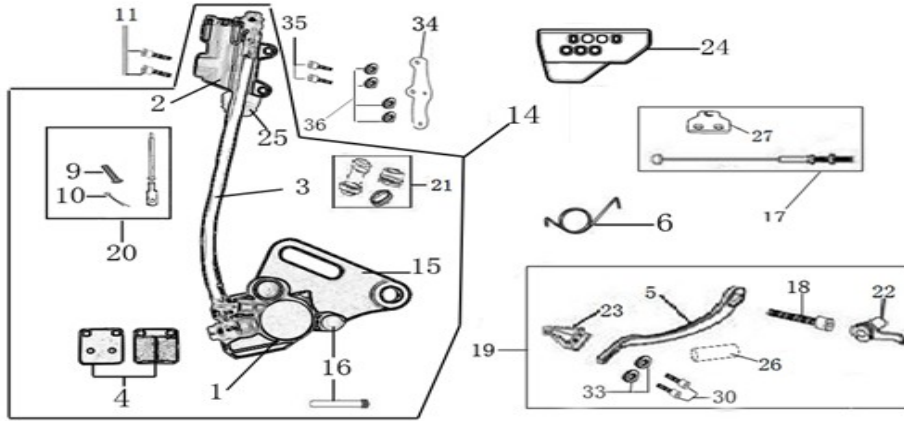





| N° | Ref.             | Description   | Français  | Picture   | Qty/Bike | Model   |
|----|------------------|---|---|---|----------|---|
| 1  | YC110-1101-16-BK | Complete ALUMINIUM Rear wheel 1.85x12' with disk and sprocket CNC BLACK hub BLACK Rim 2021 8K | roue arriere complète ALUMINIUM 1.85x12' avec disque et moyeux cnc NOIR / Jante NOIRE 2021 8K |    | 1        | SP221/SP321   |
| 3  | CHAMBRE12        | Tube for Rear tire 3.00x12'   | chambre air 3.00x12' standard   |    | 1        | L1251920/S1251920/S125SE1920/P1251920/P1501920/SP21920/SP31920  |
| 4  | 80/100/12ARRO    | Rear tyre 80/100/12 ARRO 2015   | Pneu arriere 80/100/12 ARRO 2015  |    | 1        | SP21621/SP31621   |
| 7  | YC110-1107-24-BK | ALUMINIUM 7116 Rim 1.85x12' BLACK 8K  | cerceau roue 1,85x12' ALUMINIUM 7116 NOIR 8K  |   | 1        | SP21821/SP31820   |
| 8  | YC110-1122-16-BK | YCF Rear hub CNC BLACK 2021 (SPOKES 4 mm - 8K)  | Moyeux arrière CNC 2021 NOIR (RAYONS 4 mm -8K)  |  | 1        | SP221/SP321/BFD19020/BFZ19021   |
| 9  | YC110-1109-07    | Rear hub axle bushing d17mmxd25mmx67mm  | entretoise intérieur moyeux arrière d17mmxd25mmx67mm  |  | 1        | SP21621/SP31621/BF1501720/BFD1901721/BFZ1901821   |
| 10 | 6003             | NTN Ball bearing 6003 35mmxd17mmx10mm   | Roulement roue 6003 NTNd35mmxd17mmx10mm   |  | 3        | SP21621/SP31621/BF1501720/BFD1901721/BFZ1901821   |
| 18 | YC110-0611       | OIL SEAL d23mmxd35mmx5mm  | joint spy roue d23mmxd35mmx5mm  |  | 2        | W88E1821/L881721/S88SE1521/L1251621/S12551019/S1255E1521/S12521/P1251321/P1501020/SM1251021/SM1501020/SP11017/SP21020/SP31421/B1251721/B1501721/BF1501721/BFD1901721/BFZ1901821/S1471821/S1871821 |
| 21 | JR12-13.5-8K     | set of spoke 12' (125mmx32) 8K (4.0mm) set of spoke 12' (125mmx32) 8K (4.0mm)                 | jeu rayon arrière 12' (125mmx32) 8K (4.0mm) jeu rayon arrière 12' (125mmx32) 8K (4.0mm)       |  | 1        | SP21321/SP31321   |
| 11 | YC110-11-047     | Rear wheel spacer right d15mmxd22mmx43mm with step d15mmxd17mmx14mm                           | Entretoise roue arriere droite d15mmxd22mmx43mm step d15mmxd17mmx14mm                         |  | 1        | SP21621/SP31621/BF1501720/BFD1901721/BFZ1901821   |
| 12 | YC110-11-057     | Rear wheel spacer left d15mmxd22mmx63mm with step d15mmxd17mmx25mm                            | Entretoise roue arriere gauche d15mmxd22mmx63mm step d15mmxd17mmx25mm                         |  | 1        | SP21621/SP31621/BF1501720/BFD1901721/BFZ1901821   |
| 14 | YC110-11-062/45  | YCF Driven sprocket 420-45T 5 holes   | Couronne acier 420-45T YCF 5 trous  |  | 1        | SP11617/SP21621/SP31621/B1251721/B1501721/BF1501721/BFD1901721/BFZ1901821   |
|    | KVC-2 -MP        | Rear sprocket screws kit M8x30mm (set of 5) (BT08-M8x30-W+GB6189-M8-W+GB93-d8-W)              | Kit vis fraisees M8x30 (lot de 5) (BT08-M8x30-W+GB6189-M8-W+GB93-d8-W)                        |  | 1        | SP11617/SP21621/SP31621/B1251721/B1501721/BF1501721/BFD1901721/BFZ1901821   |
| 15 | YC110-1115-01    | Rear Brake disc d200mm 2016   | Disque frein arrière d200 mm 2016   |  | 1        | W88E1821/S88SE1620/L881620/L1251621/S1255E1620/S12551619/S12521/P1251621/P1501621/SM1251620/SM1501621/SP11617/SP21621/SP31621/B1251721/B1501721/BF1501721/BFD1901721/BFZ1901721/S1471821/S1871821 |

|    |              |   |                              |   |   |   |
|----|--------------|---|------------------------------|---|---|---|
|    | KVD          | Disk screws kit (contain GB70.2-M8x16-Cr 4EA) | KIT VIS DISQUE M8x16 (lot 4) |   | 1 | W88E1821/S88SE1620/L881721/L1251621/S12551619/S1255E1521/S12521/P1251621/P1501621/SM1251620/SP11617/SP21621/SP31621/B1251721/B1501721/BF1501619/BFD1901721/BFZ1901821/S1471821/S1871821 |
| 17 | YC110-11-01  | Tire lining for 12'front/rear                 | fond jante 12'               |  | 1 | L1251621/S1255E1521/S12551219/S12521/P1251321/P1501220/SM1251220/SP11317/SP21321/SP31321  |
| 19 | GRIPSTERAR-R | Reinforced gripster - 1.85                    | Gripster renforce - 1.85     |  | 1 | SP1217/SP21221/SP31220/BF1501721/BFD1901721/BFZ1901821  |

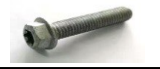
**REAR BRAKE**





| N° | Ref.             | Description   | Français  | Picture   | Qty/Bike | Model  |
|----|------------------|---|---|---|----------|--|
| 14 | YC110-12012-2601 | Rear brake aasy 1 piston d10mm/d10mm L=465mm 2020   | Kit frein arriere 1 piston avec gaine plastic d10mm/d10mm L=465mm SP3 2020  |   | 1        | SP21621/BF1501721  |
| 11 | BT08-M6x20-W     | HEXAGON Torx screw with Flange M6x20mm  | Vis HEXAGONALE Torx avec Flange M6x20mm   |  | 2        | W88E20/S88SE21/L8821/L12521/S1255E21/S12521/P12521/P15021/SM12520/SM15021/SP221/SP321/B12520/B15021/BFD19020/BFZ19021/S14720/S18721            |
| 1  | YC110-1201-07    | Rear Caliper 1 pistons d10  | étrier frein arriere 1 piston d10   |  | 1        | SP21621/SP31621/BF1501721/BFD1901721/BFZ1901821  |
| 4  | YC110-1204-02    | Friction pad for 1 piston brake w/t abestos with copper substrate                         | plaquette frein arriere 1 piston SANS AMIANTE   |  | 2        | SP21621/SP31621/BF1501721/BFD1901721/BFZ1901821  |
| 15 | YC110-1201-09    | Rear brake bracket SP3  | patte fixation étrier frein arriere SP3   |  | 1        | SP21621/SP31621/BF1501721/BFD1901721/BFZ1901821  |
| 16 | YC110-0555-01    | caliper screw for front brake L=55mm  | Vis plaquette frein avant L=55mm  |  | 2        | SP11617/SP21621/SP31621/BF1501721/BFD1901721/BFZ1901821  |
| 21 | YC110-120111     | rubber for rear caliper SP2/SP3   | jeu de caoutchouc d'etrier frein arriere SP2/SP3  |  | 1        | SP11617/SP221/SP321/BFD19020/BFZ19021/S14720/S18721  |
| 2  | YC110-1201024    | Rear reservoir d10mm ( with stick L=42.5mm ) Rear reservoir d10mm ( with stick L=42.5mm ) | maitre cylindre frein arriere avec embout durite d10mm ( with stick L=42.5mm ) maitre cylindre frein arriere avec embout durite d10mm ( with stick L=42.5mm ) |  | 1        | P1251621/P1501621/SM1501621/SP11617/SP21621/SP31621/B1251721/B1501721/BF1501721/BFD1901721/BFZ1901821/S1471821/S1871821                        |
| 9  | GB882-d7x16-W    | Pin shaft d7mmx16mm for push rod  | axe d7mmx16mm pour fixation tige  |  | 1        | W88E1821/S88SE1620/S1255E1620/S12521/P1251621/P1501621/SM1251620/SM1501621/B1251721/B1501721/BF1501721/BFD1901721/BFZ1901821/S1471821/S1871821 |
| 10 | GB91-d1.6x16-W   | Split pin d1.6mmx16mm   | Goupille d1.6mmx16mm  |  | 1        | ALL BIKES 1221   |
| 3  | YC110-1201052    | Oil steel tube L=465mm d10mm/d10mm SP2/SP3 2020 oil connection 85°                        | Durite frein arriere L=465mm d10mm/d10mm SP2 2020   |  | 1        | SP221/SP321  |
|    | YC110-1232-02    | Brake Clevis  | Embout Maitre Cylindre de Frein Arriere 2017  |  | 1        | SP116/SP21718/SP31720  |

|    |                 |   |  |   |   |   |
|----|-----------------|---|--|---|---|---|
| 19 | YC110-219-03    | complete brake pedal CNC -20mm (WITH: YC110-1223-02 2EA+BT08-M6x25 2EA+YC110-1222-01 1EA+GB70.1-M10x35-W 1EA+GB70-M5x10 3EA+FB20-10x14x2-W—个) complete brake pedal CNC -20mm (WITH: YC110-1223-02 2EA+BT08-M6x25 2EA+YC110-1222-01 1EA+GB70.1-M10x35-W 1EA+GB70-M5x10 3EA+FB20-10x14x2-W—个) | Pedale de frein complete CNC-20mm (WITH: YC110-1223-02 2EA+BT08-M6x25 2EA+YC110-1222-01 1EA+GB70.1-M10x35-W 1EA+GB70-M5x10 3EA+FB20-10x14x2-W—个) |     | 1 | SP221/SP321/BFD19020/BFZ19021/S14720/S18721   |
| 6  | YC110-21-06     | Spring for ALUMINIUM brake pedal d38  | Ressort pour pédale de frein ALUMINIUM d38   |    | 1 | SP221/SP321/BF15020/BFD19020/BFZ19021/S14720/S18721   |
|    | FB20-10X14X2-W  | Flat washer d10Xd13.5X1.5   | rondelle d10Xd13.5X1.5   |    | 1 | SP1520/BIGYF150Mx1720/BIGYFD200Mx1721/BIGY200ZE21   |
| 22 | YC110-1222-01   | Brake pedal fixation for Aluminium pedal with bearing BLACK   | Cylindre pédale de frein Aluminium "externe" NOIR avec roulements  |    | 1 | SP11617/SP221/SP321/BFD19020/BFZ19021/S14720/S18721   |
| 18 | GB70.1-M10x35-W | Nut for brake pedal M10X35  | vis pour pédale frein M10X35   |    | 1 | SP11617/SP21621/SP31621/BF1501721/BFD1901721/BFZ1901821   |
|    | FB13-10x14x6    | bushing 10x14x6MM for brake pedal   | entretoise 10x14x6MM pour pédale de frein  |    | 1 | SP11617/SP221/SP321/BFD19020/BFZ19021/S14720/S18721   |
| 23 | YC110-1223-02   | Aluminium brake pedal end cap 2020  | embout pédale de frein Aluminium 2020  |    | 1 | SP221/SP321/BFD19020/BFZ19021/S14720/S18721   |
| 30 | BT08-M6x16-W    | HEXAGON Torx screw with Flange M6x16mm  | Vis HEXAGONALE Torx avec Flange M6x16mm  |    | 2 | SP221/SP321/BFD19020/BFZ19021/S14720/S18721   |
|    | 6900Z           | Ball bearing 6900Z d10xd22x6mm  | 6900Z d10mmxd22mmx6mm pour roulette de chaine  |    | 2 | SP11617/SP221/SP321/BFD19020/BFZ19021/S14720/S18721   |
|    | GB70-M5x12      | HEXAGON SOCKET Head Bolt M5x12mm  | Vis Allen (BTR) M5x12mm  |   | 3 | SP11617/SP221/SP321/BFD19020/BFZ19021/S14720/S18721   |
| 34 | YC110-1215-06   | Mount for rear break reservoir "extern"   | fixation maitre cylindre frein arriere "externe"   |  | 1 | P1251720/P1501720/SM1501720/SP11719/SP21720/SP31720/B1251721/B1501721/BFD1901721/BFZ1901821/S1471821/S1871821 |
| 35 | BT08-M6x12-W    | HEXAGON Torx screw with Flange M6x12mm  | Vis HEXAGONALE Torx avec Flange M6x12mm  |  | 2 | P12521/P15021/SM15021/SP221/SP321/B12520/B15021/BFD19020/BFZ19021/S14720/S18721                               |
|    | BT08-M6x16-W    | HEXAGON Torx screw with Flange M6x16mm  | Vis HEXAGONALE Torx avec Flange M6x16mm  |  | 2 | P12521/P15021/SM15021/SP221/SP321/B12520/B15021/BFD19020/BFZ19021/S14720/S18721                               |

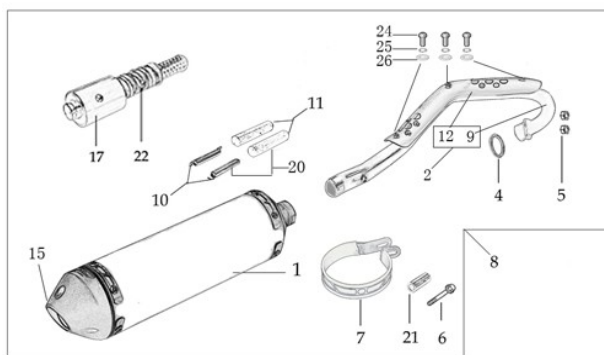
#### Exhaust system









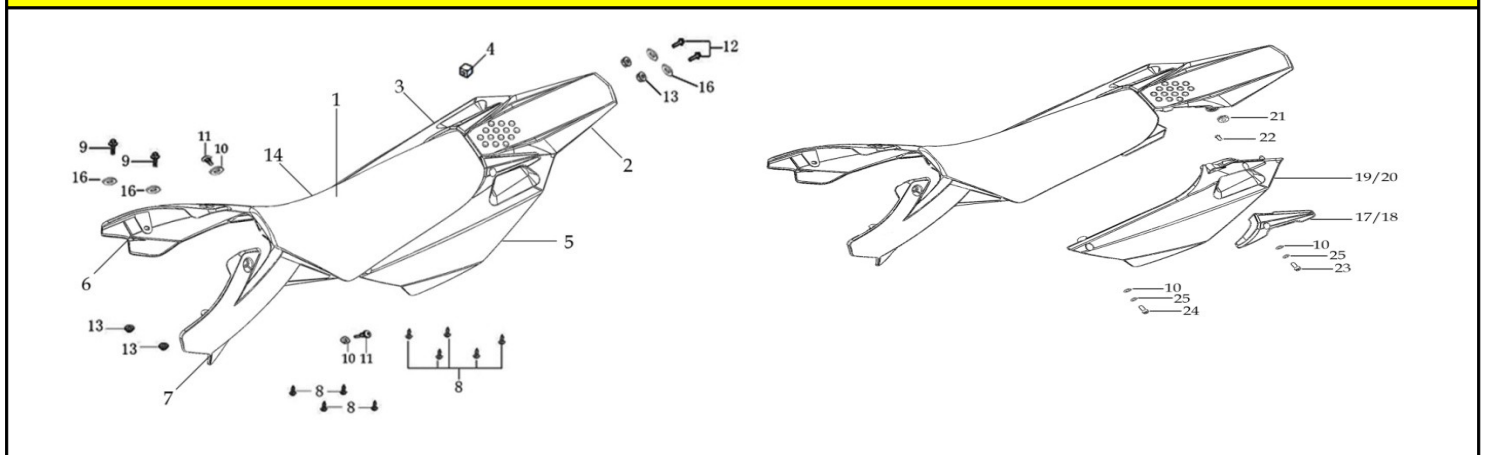















| N° | Ref.              | Description                                     | Français                                     | Picture   | Qty/Bike | Model   |
|----|-------------------|---|--|---|----------|---|
| 1  | YC110-139-0301    | Muffler& Exhaust pipe assy YCF SPII/SPIII 2020  | Echappement complet YCF 94db SPII/SPIII 2020 |  | 1        | SP221/SP321                                     |
| 2  | YC110-13014-03-BK | Muffler RACING (2 springs) (semi product) Black | silencieux YCF SP3 RACING (semi fini) Noir   |  | 1        | SP21621/SP31621/BF1501619/BFD1901721/BFZ1901821 |
| 4  | YC110-1317-02     | Noise reducer (spark arrestor) YCF SP           | Bride de pot YCF SP                          |  | 1        | SP21621/SP31621/BF1501619/BFD1901721/BFZ1901821 |

|    |               |  |  |   |   |   |
|----|---------------|--|--|---|---|---|
| 5  | GB70-M5x6     | Plus screw M5x6mm for muffler end cap  | vis M5x6mm pour Embout silencieux  |      | 1 | SP21621/SP31621/BF1501619/BFD1901721/BFZ1901821   |
| 6  | YC110-13-35   | Muffler end cap SPII   | Embout silencieux racing SPII  |    | 1 | SP21221/SP31220/BF1501721/BFD1901721/BFZ1901821/S1471821/S1871821   |
| 7  | GB70-M5x16    | HEXAGON SOCKET Head Bolt M5x16mm   | Vis Allen (BTR) M5x16mm  |    | 3 | SP21221/SP31220/BF1501721/BFD1901721/BFZ1901821/S1471821/S1871821   |
| 8  |               | Spring Lock Washers d6mm   | Rondelle à ressort d6mm  |    | - | SP21221/SP31220/BF1501721/BFD1901721/BFZ1901821/S1471821/S1871821   |
| 9  | YC110-1302-34 | Exhaust pipe with protection plate d28/32mm SP 2022                          | collecteur avec plaque d28/32mm SP 2022collecteur avec plaque d28/32mm SP 2022 |    | 1 | SP21522   |
| 10 | 18291/152FMH  | Exhaust pipe washer d25.5mmx32mmx4mmExhaust pipe washer d25.5mmx32mmx4mm     | joint pot d25.5mmx32mmx4mm   |    | 1 | S885E1521/L881721/L1251621/S1255E1521/S12521/P1251321/P1501220/SM1251220/SM1501220/SP11219/SP21221/SP31421/B1251721/B1501721/BFD1901721/BFZ1901821/S1471821/S1871821                    |
| 11 | GB6187-M6-W   | HEXAGON FLAT FLANGE LOCK NUT M6  | Ecrou HEXAGONAL avec Flange autobloquant M6                                    |    | 2 | S885E1521/L881721/L1251621/S1255E1521/S12521/S1251219/P1251321/P1501220/SM1251220/SM1501220/SP11217/SP21221/SP31421/B1251721/B1501721/BF1501721/BFD1901721/BFZ1901821/S1471821/S1871821 |
| 12 | YC110-1312-10 | Exhaust pipe with protection plate d28/32mm SP 2022                          | collecteur avec plaque d28/32mm SP 2022collecteur avec plaque d28/32mm SP 2022 |    | 1 | SP221   |
| 13 | BT08-M6x10-W  | HEXAGON Torx screw with Flange M6x10mm                                       | Vis HEXAGONALE Torx avec Flange M6x10mm  |    | 3 | ALL BIKES 21  |
| 14 | GB97-d6-W     | Flat washer d6mm   | Rondelle plate d6mm  |    | 3 | ALL BIKES 1520  |
| 15 | YC110-1307-03 | Hoop for muffler YCF SPII/SPIII (with FB13-8x14x35-W 1EA+GB5787-M8x60-W 1EA) | Attache silencieux YCF SPII/SPIII 2015 (DROIT)                                 |   | 1 | SP21521/SP31521   |
| 23 | BT08-M8x60-W  | HEXAGON Torx screw with Flange M8x60mm                                       | Vis HEXAGONALE Torx avec Flange M8x60mm  |  | 1 | SP221/SP321   |
| 24 | BT08-M6x16-W  | HEXAGON Torx screw with Flange M6x16mm                                       | Vis HEXAGONALE Torx avec Flange M6x16mm  |  | 1 | SP21221/SP31220/BF1501721/BFD1901721/BFZ1901821/S1471821/S1871821   |
| 25 | GB6177-M6-W   | HEXAGON FLAT FLANGE NUT M6   | Ecrou HEXAGONAL avec Flange M6   |  | 2 | SP21221/SP31220/BF1501721/BFD1901721/BFZ1901821/S1471821/S1871821   |
| 26 | YC110-13-21   | Muffler spring with rubber L=50mm  | Ressort pot avec le caoutchouc pour silencieux L=50mm                          |  | 2 | S885E1521/S8851516/L881721/L1251621/S1255E1521/S12521/P1251420/P1501420/SM1251320/SM1501320/SP21321/B1251721/B1501721/BF1501721/BFZ1901721/S1471821/S1871821                            |

### Seat & Plastic kit



| N° | Ref.          | Description           | Français         | Picture   | Qty/Bike | Model                                       |
|----|---------------|-----------------------|------------------|---|----------|---|
| 1  | YC110-1401-17 | YCF Seat assy L=510mm | Sells SP L=510mm |  | 1        | P1251821/P1501821/SM1501821/SP21821/SP31820 |

|    |                  |  |  |   |   |   |
|----|------------------|--|--|---|---|---|
| 3  | YC110-14-018-WH  | YCF Rear fender 2016 WHITE with YC110-1404-01 2EA            | Garde boue arrière YCF 2016 avec Picots BLANC                        |     | 1 | P1251621/P1501621/SM1501621/SP11617/SP21621/SP31621   |
| 6  | YC110-14-028-WH  | YCF right side plastic assy 2016 WHITE                       | Plaque latérale droite YCF 2016 BLANC                                |    | 1 | P1251621/P1501621/SM1501621/SP11617/SP21621/SP31621   |
| 7  | YC110-1428-01-BK | Handrail of right side plastic 2016 BLACK                    | Poignee droite plaques laterales FACTORY 2016 NOIR                   |    | 1 | P1251621/P1501621/SM1501621/SP11617/SP21621/SP31621   |
| 9  | YC110-14-03      | Cushion for right side plastic BLACK                         | caoutchouc plaque laterale droite NOIR                               |    | 1 | ALL BIKES 1121  |
| 10 | YC110-14-048-WH  | YCF left side plastic assy 2016 WHITE                        | Plaque laterale gauche YCF 2016 BLANC                                |    | 1 | P1251621/P1501621/SM1501621/SP11617/SP21621/SP31621   |
| 11 | YC110-1429-01-BK | Handrail of left side plastic 2016 BLACK                     | Poignee gauche plaques laterales FACTORY 2016 NOIR                   |    | 1 | P1251621/P1501621/SM1501621/SP11617/SP21621/SP31621   |
| 13 | GB822-M5x10-W    | Plus screw M5x10mm   | vis M5x10mm  |    | 2 | P1251621/P1501621/SM1501621/SP11617/SP21621/SP31621/B1251721/B1501721/BF1501721/BFD1901721/BFZ1901821   |
| 14 | YC110-1404-01    | Rubber plug Hoop for muffler d8.2mmxd20.2mmx9mm BLACK        | caoutchouc plaque laterale d8.2mmxd20.2mmx9mm 2016                   |    | 2 | P1251621/P1501621/SM1501621/SP11617/SP21621/SP31621/B1251721/B1501721/BF1501721/BFD1901721/BFZ1901821   |
| 6  | YC110-14-059-YE  | Right shroud SP 2017 YELLOW                                  | ouie radiateur droite SP 2017 JAUNE                                  |    | 1 | W88E22/S88SE22/S125SE22/S12522/P1251822/P1501822/SM12522/SM1501822/SP117/SP22722/SP31722  |
| 7  | YC110-14-069-YE  | Left side shroud SP2017 YELLOW                               | ouie radiateur gauche SP2017 JAUNE                                   |   | 1 | W88E22/S88SE22/S125SE22/S12522/P1251822/P1501822/SM12522/SM1501822/SP117/SP22722/SP31722  |
| 21 | GB845-ST4.8x16-G | Pan Head Cross Tapping Screw ST4.8x16mm                      | Vis taraudeuse à tête ronde cruciforme ST4.8x16mm                    |  | 8 | 50A1120/50E1620/W88E1821/S88SE1420/L881721/L1251621/S125S1219/S125SE1521/S12521/P1251321/P1501220/SM1251220/SM1501220/SP11217/SP21221/SP31421 |
| 22 | GB845-ST4.8x20-G | Pan Head Cross Tapping Screw ST4.8x20mm                      | Vis taraudeuse à tête ronde cruciforme ST4.8x20mm                    |  | 1 | P1251321/P1501320/SM1501320/SP11316/SP21321/SP31321   |
| 23 | GB819-M4x10-W    | Countersunk cross head machine screw,iron, M4x10mm,          | Vis à tête fraisée plate cruciforme M4x10mm                          |  | 8 | W88E20/S88SE21/S125SE21/S12521/P1251821/P1501821/SM12520/SM1501821/SP11617/SP21621/SP31621  |
| 24 | BT08-M6x20-W     | HEXAGON Torx screw with Flange M6x20mm                       | Vis HEXAGONALE Torx avec Flange M6x20mm                              |  | 2 | ALL BIKES 21  |
| 25 | YC110-02-13      | Rubber washer d6mmxd14mmx3mm for shroud fixation on gas tank | rondelle d5mmxd15mm pour fixation ouies sur reservoir cotes          |  | 2 | ALL BIKES 1220  |
| 26 | FB5787-M5x12-W   | hex.Bolt with flanged M5x12mm                                | Vis M5x12mm  |  | 2 | ALL BIKES 1220  |
| 27 | GB96-d6          | Flat washer d6mm   | Rondelle plate d6mm  |  | 2 | ALL BIKES 1220  |
| 28 | GB6177-M6-W      | HEXAGON FLAT FLANGE NUT M6                                   | Ecrou HEXAGONAL avec Flange M6                                       |  | 1 | ALL BIKES 1220  |
| 29 | BT08-M6x25-W     | HEXAGON Torx screw with Flange M6x25mm                       | Vis HEXAGONALE Torx avec Flange M6x25mm                              |  | 2 | ALL BIKES 1520  |
| 30 | YC110-03-01      | Rubber washer d6mmxd18mmx4mm for seat fixation on subframe   | joint caoutchouc d6mmxd18mmx4mm pour fixation selie sur boucle acier |  | 2 | ALL BIKES 1220  |
| 31 | GB96-d6          | Flat washer d6mm   | Rondelle plate d6mm  |  | 2 | ALL BIKES 1220  |

ELECTRIC

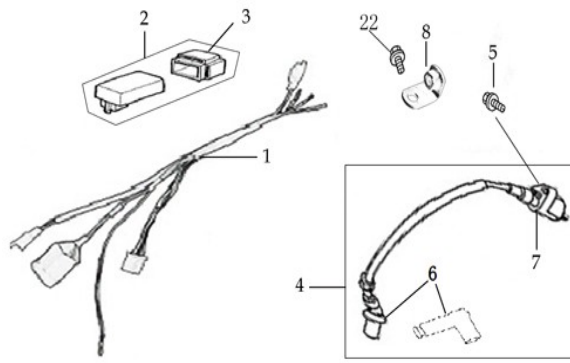





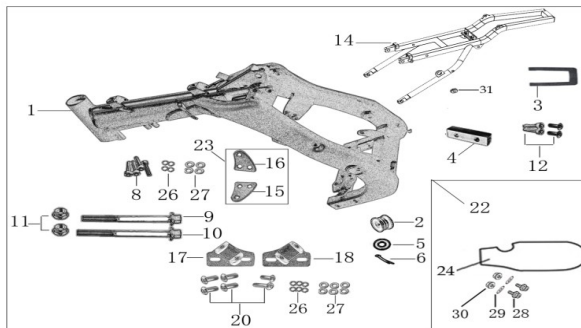

| N° | Ref.           | Description                                 | Français  | Picture | Qty/Bike | Model  |
|----|----------------|---|---|---------|----------|--|
| 1  | YC110-1501-21  | Wire harness 2020 (all kick start 2020)     | Faisceaux électrique 2020 (toutes motos demareur kick 2020) |         | 1        | L8821/L12521/S12521/P12521/P15021/SM12520/SM15021/SP221/B12520/B15021/S14720   |
|    | YC110-01-05-WH | Cable tie L=350mm WHITE                     | collier maintien cable L=350mm BLANC                        |         | 1        | ALL BIKES 1220   |
| 2  | YC110-1503     | CDI Ignitor assy.                           | CDI Ignitor assy.   |         | 1        | L881721/L1251621/S12521/S1255E1521/S12551519/P1251321/P1501320/SM1251220/SM1501220/SP11217/SP21221/B1251721/B1501721/BF1501721/BFZ1901821/S1471821           |
| 4  | YC110-1504-02  | Ignitor coil L=240mm                        | bobine haute tension L=240mm                                |         | 1        | F88L20/F125L20/F1251216/F125e1220/F125se1520/P88s1215/P1251317/P1501320/SM1220/SP11417/SP21421   |
| 6  | YC110-1505     | anti interference red                       | anti parasite rouge   |         | 1        | S885E1521/L881721/L1251621/S12551219/S1255E1521/S12521/P1251420/P1501220/SM1251220/SM1501220/SP11217/SP21221/B1251721/B1501721/BF1501721/BFZ1901721/S1471821 |
| 7  | YC110-1504     | Ignitor coil                                | bobine haute tension (sans anti parasite)                   |         | 1        | S885E1521/L881721/L1251621/S12551219/S1255E1521/S12521/P1251420/P1501220/SM1251220/SM1501220/SP11217/SP21221/B1251721/B1501721/BF1501721/BFZ1901721/S1471821 |
| 5  | BT08-M6x20-W   | HEXAGON Torx screw with Flange M6x20mm      | Vis HEXAGONALE Torx avec Flange M6x20mm                     |         | 1        | ALL BIKES 21   |
| 8  | YC110-1506     | The Ignitor coil stents L=23mm H=17mm BLACK | Support Bobine Haute tension L=23mm H=17mm Noir             |         | 1        | SP11317/SP21321/B1251721/B1501721/BF1501721/BFZ1901821   |
| 22 | BT08-M6x16-W   | HEXAGON Torx screw with Flange M6x16mm      | Vis HEXAGONALE Torx avec Flange M6x16mm                     |         | 1        | ALL BIKES 21   |

### Frame





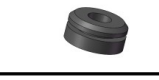

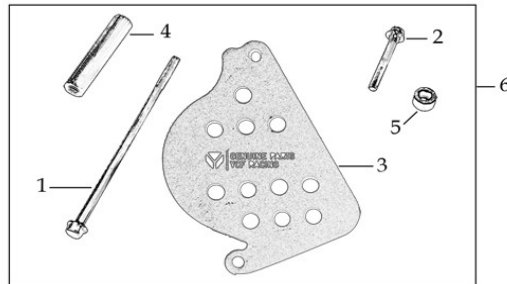

| N° | Ref.              | Description  | Français   | Picture | Qty/Bike | Model       |
|----|-------------------|--|--|---------|----------|-------------|
| 21 | YC110-171-0301-BK | complète frame SPII 2020 BLACK   | cadre complet SPII 2020 NOIR                                 |         | 1        | SP221       |
| 1  | YC110-181-0501-BK | Chromoly steel frame body SPI / SPII / SPIII 2020 BLACK 22 degrees<br>Chromoly steel frame body SPI / SPII / SPIII 2020 BLACK 22 degrees<br>Chromoly steel frame body SPI / SPII / SPIII 2020 BLACK 22 degrees | Cadre acier chromoly SPI / SPII / SPIII 2020 NOIR 22 degrees |         | 1        | SP221/SP321 |

|    |                  |  |   |   |    |  |
|----|------------------|--|---|---|----|--|
|    | YC110-01-08-BK   | Cable tie, PA66 L=80mm ADJUSTABLE BLACK                  | Collier maintien cable,PA66 L=80mm AJUSTABLE NOIR   |     | 3  | ALL BIKES 21   |
| 2  | YC110-2201-02    | YCF Chain tensioner component Nylon 2020                 | Roulette chaine YCF<br>2020 NylonRoulette chaine YCF<br>2020 NylonRoulette chaine YCF<br>2020 Nylon |    | 1  | S885E21/L8821/L12521/S1255E21/S12521/P12521/P15021/SM12520/SM15021/SP221/SP321/B12520/B15021/BFD19020/BFZ1901721/                |
| 5  | GB97-d10-W       | Flat washer d10.5mmxd20mmx2mm                            | Rondelle plate d10.5mmxd20mmx2mm  |    | 1  | ALL BIKES 1121   |
| 6  | GB91-d2x25-W     | Split pin 2.0x25mm                                       | Goupille 2.0x25mm   |    | 1  | ALL BIKES 1321   |
| 14 | YC110-1614-15-BK | STEEL Subframe part SP1/SP2 BLACK with YC110-1404-01 2EA | Boucle arriere de cadre ACIER SP1/SP2 NOIR  |    | 1  | SP11617/SP21720  |
|    | YC110-1633-01    | Rubber plug for SUBFRAME part BIGY YCF                   | Embout Caoutchouc YCF boucle arriere Bigy YCF   |    | 1  | P1251720/P1501720/SM1501720/SP116/SP21720/B1251721/B1501721/BF1501721/BFZ1901821/S1471821/S1871821                               |
| 22 | YC110-16-066-BK  | set of engine pads Black SPI/SPII/SPIII                  | jeu de patte de cadre Noir SPI/SPII/SPIII   |    | 1  | SP11317/SP21221/SP31220  |
| 15 | YC110-16-033-BK  | frame engine pads left SPI/SPII/SPIII BLACK              | patte de cadre gauche SPI/SPII/SPIII NOIRE  |    | 1  | SP11317/SP21221/SP31220  |
| 16 | YC110-16-043-BK  | frame engine right left SPI/SPII/SPIII BLACK             | patte de cadre droite SPI/SPII/SPIII NOIRE  |    | 1  | SP11317/SP21221/SP31220  |
|    | YC110-0834-01    | Nord Lock M for Frame pads                               | Nord Lock Pattes de cadre   |    | 10 | SP21821/SP31820/BF1501820/FD1901820/ZE1901820  |
|    | BT08-M8x25-W     | HEXAGON Torx screw with Flange M8x25mm                   | Vis HEXAGONALE Torx avec Flange M8x25mm   |  | 4  | SP21221/SP31220  |
| 8  | BT08-M8x20-W     | HEXAGON Torx screw with Flange M8x20mm                   | Vis HEXAGONALE Torx avec Flange M8x20mm   |  | 4  | P12521/P15021/SM15021/B12520/B15021/BFD19020/BFZ19021/S14720/S18721  |
| 9  | BT08-M8x125-W    | HEXAGON Torx screw with Flange M8x125mm                  | Vis HEXAGONALE Torx avec Flange M8x125mm  |  | 1  | SP221/SP321/B12520/B15021/BFD19020/BFZ19021  |
| 10 | BT08-M8x105-W    | HEXAGON Torx screw with Flange M8x105mm                  | Vis HEXAGONALE Torx avec Flange M8x105mm  |  | 1  | 50A/S885E21/L8821/L12521/S1255E21/S12521/P12521/P15021/SM12520/SM15021/SP221/SP321/B12520/B15021/BFD19020/BFZ19021/S14720/S18721 |
| 12 | GB70.2-M8x20     | screw M8x20mm  | vis M8x20mm   |  | 2  | SP11317/SP21321/SP31321  |
| 11 | GB6187-M8-W      | Self locking nut M8 for frame engine aluminium pads      | ecrou M8 pour patte de cadre  |  | 2  | ALL BIKES  |
|    | GB6187-M8-W      | HEXAGON FLAT FLANGE LOCK NUT M8                          | Ecrou HEXAGONAL avec Flange autobloquant M8   |  | 2  | SP11317/SP21321/SP31321  |
| 17 | YC110-16-051-BK  | foot pegs support left SPI/SPII/SPIII BLACK              | support repose pied gauche SPI/SPII/SPIII NOIR  |  | 1  | SP11317/SP21321/SP31321  |
| 18 | YC110-16-055-BK  | foot pegs support right SPI/SPII/SPIII BLACK             | support repose pied droite SPI/SPII/SPIII NOIR  |  | 1  | SP11317/SP21321/SP31321  |
| 20 | GB70.2-M8x25     | Pan head hexagon screw M8 x25 mm                         | Vis à tête ronde Allen (BTR) M8x25 mm   |  | 5  | SP11317/SP21321/SP31321  |
|    | GB70.2-M8x50-Cr  | Screw M8x50mm Chrome-plated                              | Vis M8x50mm Chrome  |  | 1  | SP11317/SP21321/SP31321  |
| 26 | GB93-d8-W        | Spring Lock Washers d8mm                                 | Rondelle a ressort d8mm   |  | 5  | SP11317/SP21321/SP31321  |
| 27 | GB97-d8-W        | Flat washer d8mm   | Rondelle plate d8mm   |  | 5  | SP11317/SP21321/SP31321  |
| 30 | GB6187-M8-W      | HEXAGON FLAT FLANGE LOCK NUT M8                          | Ecrou HEXAGONAL avec Flange autobloquant M8   |  | 1  | SP11617/SP21621/SP31621/B1251721/B1501721/BF1501721/BFD1901721/BFZ1901821  |

|    |               |  |  |   |   |   |
|----|---------------|--|--|---|---|---|
| 24 | YC110-0460-01 | Complete Rear shock absorber rubber protection             | Bavette caoutchouc Complete  |   | 1 | SP11617/SP21621/SP31621/81251721/81501721/BF1501721/BFD1901721/BFZ1901821                     |
| 28 | BT08-M6x20-W  | HEXAGON Torx screw with Flange M6x20mm                     | Vis HEXAGONALE Torx avec Flange M6x20mm  |  | 2 | SP221/SP321/812520/815021/BFD19020/BFZ19021   |
| 29 | GB96-d6-W     | Flat washer d6mm   | Rondelle plate d6mm  |  | 2 | SP11617/SP21621/SP31621/81251721/81501721/BF1501721/BFD1901721/BFZ1901821                     |
| 30 | YC110-03-01   | Rubber washer d6mmxd18mmx4mm for seat fixation on subframe | joint caoutchouc d6mmxd18mmx4mm pour fixation selie sur boucle acier<br>joint caoutchouc d6mmxd18mmx4mm pour fixation selie sur boucle acier |  | 2 | SP11617/SP21621/SP31621/81251721/81501721/BF1501721/BFD1901721/BFZ1901821                     |
| 31 | YC110-1404-01 | Rubber plug Hoop for muffler d8.2mmxd20.2mmx9mm BLACK      | caoutchouc plaque laterale d8.2mmxd20.2mmx9mm 2016   |  | 2 | P1251720/P1501720/SM1501720/SP116/SP21720/81251721/81501721/BF1501721/BFZ1901821              |
|    | YC110-1635    | Complete grease nozzle                                     | Buse à graisse complète  |  | 1 | MIGY125/BIGY190D/BIGY190ZE/SP3/LIFE125/P125/SM125/SM150/STAT125/STAR125SE/SUNDAY147/SUNDAY187 |

### FRONT SPROCKET PROTECTION





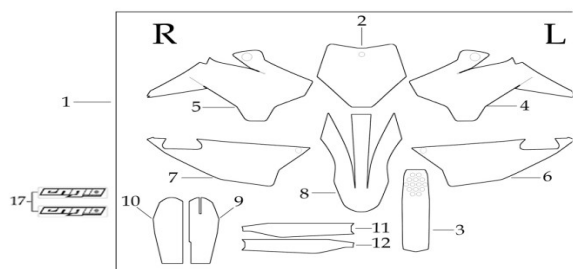

| N° | Ref.             | Description  | Français  | Picture   | Qty/Bike | Model   |
|----|------------------|--|---|---|----------|---|
|    | YC110-2004-01-GY | Complete YCF Crankcase Cover, LH for kick start engine GREY        | CARTER ALLUMAGE complet YCF pour moteur demarage avec kick GRIS |  | 1        | LITE8823/LITE12523/START12523/START12523/PILOT12523/SM12523/SM15523/SM19023/BIGY12523/BIGY15023/SP223/SP319023/BFD1923/S18723 |
|    | YC110-1803-02-BK | YCF BI-MATERIEL Front Sprocket plastic cover for kick start engine | Protection COMPOSITE YCF PSB pour moteur demarage avec kick     |  | 1        | LITE8823/LITE12523/START12523/START12523/PILOT12523/SM12523/SM15523/SM19023/BIGY12523/BIGY15023/SP223/SP319023/BFD1923/S18723 |
|    | YC110-2014-01-BK | YCF Aluminium Cap Big View Hole BLACK                              | Bouchon carter allumage CNC YCF NOIR                            |  | 1        | LITE8823/LITE12523/START12523/START12523/PILOT12523/SM12523/SM15523/SM19023/BIGY12523/BIGY15023/SP223/SP319023/BFD1923/S18723 |
|    | YC110-2019       | Chyba:511  | Chyba:511   |  | 1        | LITE8823/LITE12523/START12523/START12523/PILOT12523/SM12523/SM15523/SM19023/BIGY12523/BIGY15023/SP223/SP319023/BFD1923/S18723 |
|    | GB5787-M6x40-Cr  | HEXAGON screw with Flange M6x40mm                                  | Vis HEXAGONALE avec Flange M6x40mm                              |  | 1        | LITE8823/LITE12523/START12523/START12523/PILOT12523/SM12523/SM15523/SM19023/BIGY12523/BIGY15023/SP223/SP319023/BFD1923/S18723 |
|    | GB5787-M6x25-Cr  | HEXAGON screw with Flange M6x25mm                                  | Vis HEXAGONALE avec Flange M6x25mm                              |  | 2        | LITE8823/LITE12523/START12523/START12523/PILOT12523/SM12523/SM15523/SM19023/BIGY12523/BIGY15023/SP223/SP319023/BFD1923/S18723 |

### GRAPHICS

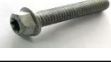

| N° | Ref. | Description | Français | Picture | Qty/Bike | Model |
|----|------|-------------|----------|---------|----------|-------|
|----|------|-------------|----------|---------|----------|-------|

|                |                 |  |   |   |   |  |
|----------------|-----------------|--|---|---|---|--|
| 1              | KDSP22023       | SP2 complete graphic kit 2023          | Kit deco complet SP2 2023               |   | 1 | SP223  |
| <b>ENGINES</b> |                 |  |   |   |   |  |
|                | MOTEUR150-01    | ENGINE YX 150-2                        | MOTEUR YX 150-2                         |  | 1 | SP21521/BF1501721  |
|                | YC140-27600-SI  | STEEL KICK YCF BIG HOLE                | KICK ACIER GROS DIAMETRE SILVER         |  | 1 | P1501620/SM1501620/SP1517/SP22520/SP31520/B1501720/BF1501719/BFZ1901822/BFD1901720/S1471820/S1871822 |
|                | BT08-M8x25-W    | HEXAGON Torx screw with Flange M8x25mm | Vis HEXAGONALE Torx avec Flange M8x25mm |  | 1 | All Bike20   |
|                | 24700/152FMH/03 | Gearshift Pedal                        | SELECTEUR                               |  | 1 | P12521/P15021/SM15021/SP221/B12520/B15021  |
|                | BT08-M6x20-W    | HEXAGON Torx screw with Flange M6x20mm | Vis HEXAGONALE Torx avec Flange M6x20mm |  | 1 | All Bike20   |