



Up-Riding.com

GP
VCEP

2023

BIKE CODE FOR ORDERS:

23-GP-187-STD
23-GP-157-STD
23-GP-107-STD

3.7.2023

BIKES DESCRIPTIONS NAME:

GP107 /



GP157





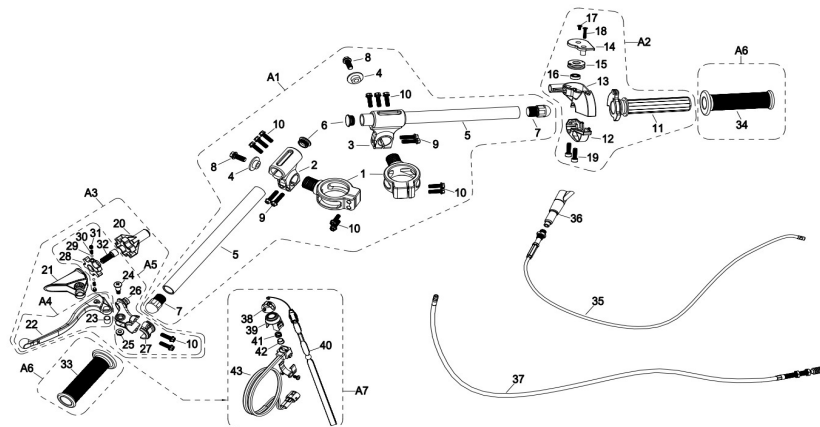



/ GP187
DAYTONA



Handle bar assembly







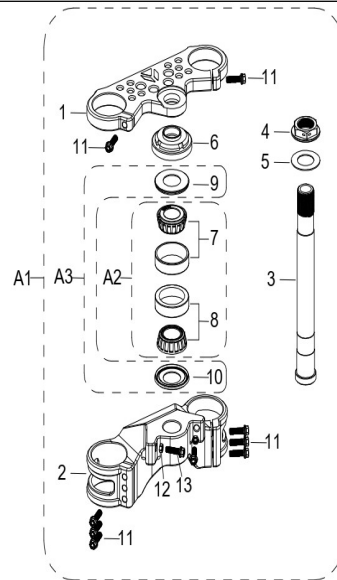

N°	Ref.	Description	Français	Picture	Qty/Bike	Model	GP187	GP157	GP107
A1	YC110-0101-31-GY	MINI GP Pair of Semi handle bar Adjustable d45 GREY	Paire de guidon bracelet MINI GP Reglable d45 GRIS		1	GP107 GP157 GP187	X	X	X
5	YC110-0101-25-BKM	MINI GP Handle bar Tube d22x2.5x272mm (unit) BLACK MAT	Tube de guidon MINI GP d22x2.5x272mm NOIR MAT (a l'unite)		2	GP107 GP157 GP187	X	X	X
6	YC110-0153-03-BKM	MINI GP Handle bar Tube PA6 END CAP	Bouchon PA66 Tube de guidon MINI GP		2	GP107 GP157 GP187	X	X	X
7	YC110-0153-02-BKM	MINI GP Handle bar End Cap Teflon BLACK MAT	Embout de guidon MINI GP Teflon NOIR MAT		2	GP107 GP157 GP187	X	X	X
8	BT08-M8x20-W	Hex.Bolt M8x20mm for clamp	vis M8x20mm pour support tube de guidon		2	GP107 GP157 GP187	X	X	X
9	BT08-M6x30-W	Hex.Bolt M6x30mm for clamp	vis M8x30mm pour support tube de guidon		4	GP107 GP157 GP187	X	X	X
10	BT08-M6x16-W	Hex.Bolt M6x16mm for clamp	vis M6x16mm pour support tube de guidon		12	GP107 GP157 GP187	X	X	X
A2	YC110-01022-N1	YCF Throttle Assy. 2014 without grip (with YC110-0102-08 1EA)	Poignee gaz reglable YCF 2014 nue		1	GP107 GP157 GP187	X	X	X
A3	YC110-0135-02	Cnc adjustable bracket with lever 2020	Cocotte CNC réglage rapide avec levier embrayage 2020		1	GP107 GP157 GP187	X	X	X
A4	YC110-0103-07	Clutch lever 2020 Al (with FB13-8x10x10.5-Cu 1EA FB13-8x10x9.4-Cu 1EA FB20-10x16x1 1EA) complete with bushings	Levier embrayage 2020 (avec FB13-8x10x10.5-Cu 1EA FB13-8x10x9.4-Cu 1EA FB20-10x16x1 1EA) avec entretoises		1	GP107 GP157 GP187	X	X	X

A5	YC110-0134-04	Clutch bracket Assy	Cocotte embrayage complete		1	GP107 GP157 GP187	X	X	X
A6	PPC012-BK	Left and right hand handle rubber cover MINIGP Black Model 2023	Manche de droite et gauche en caoutchouc MINIGP noir modèle 2023		1	GP107 GP157 GP187	X	X	X
35	YC110-0106-16	Throttle Cable L=760mm A+B=135mm	Cable gaz L=760mm A+B=135mm		1	GP187	X	X	
35	YC110-0106-20	Throttle Cable L=760mm A+B=20mm	Cable gaz L=760mm A+B=20mm		1	GP107 GP157			X
36	YC110-0143-01	Rubber on trottle cable	Protection caoutchouc cable de gas		1	GP157	X	X	X
37	YC110-0109-29	Clutch Cable Assy. L=860mm A+B=95mm	Cable embrayage L=860mm A+B=95mm		1	GP107 GP187	X		X
37	YC110-0109-30	Clutch Cable Assy. L=860mm A+B=75mm	Cable embrayage L=860mm A+B=75mm		1	GP157		X	
A7	YC110-0105-07	YCF Magnet kill switch	Coupe circuit YCF aimant		1	GP107 GP157 GP187	X	X	X
44	YC110-01-03-BK	Cable tie L=150mm BLACK	Colier maintien cable L=150mm NOIR		3	ALL BIKES 1220	X	X	X

Steering stem assembly







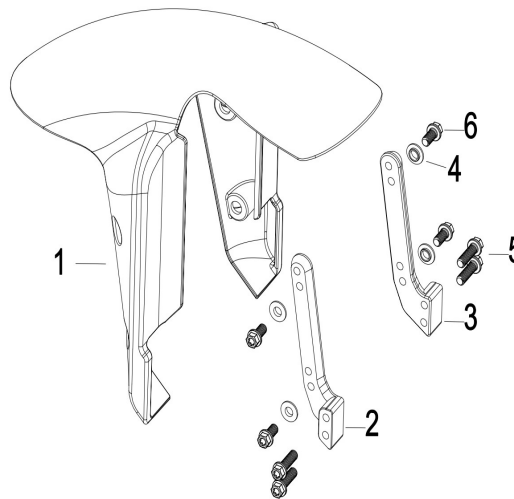

N°	Ref.	Description	Français	Picture	Qty/Bike	Model	GP187	GP157	GP107
A1	YC110-0225-04-BKM	MINI GP Complete Triple Clamp (TOP d45mm / BOTTOM d48mm) L=160mm Black Mat	Te Fourche Complet MINI GP (TE SUPd45mm / TE INF d48mm) L=160mm Noir Mat		1	GP107 GP157 GP187	X	X	X
4	3.22100N-SI	MINI GP Nut for steering stem M22 SILVER MAT	Ecrou supérieur colonne direction MINI GP M22 SILVER MAT		1	GP107 GP157 GP187	X	X	X
A2	KRDIRECTION46	Set of bearing for steering 46/23.5、 46/22	Kit rlt colonne direction 46/23.5、 46/22		1	GP107 GP157 GP187	X	X	X
A3	YC110-02-20	Washer for steering stem nut	joint colonne direction		1	GP107 GP157 GP187	X	X	X
11	BT08-M6x20-W	Hex.Bolt M6x20mm for MINI GP clamp	Vis M6x20mm pour tes MINI GP		8	GP107 GP157 GP187	X	X	X

12	GB6170-M8-W-H	HexagonalNut M8	Ecrou Hexagonal M8		2	GP107 GP157 GP187	X	X	X
13	BT08-M8x30-W	Hex.Bolt M8x30mm for clamp	vis M8x30mm pour support tube de guidon		2	GP107 GP157 GP187	X	X	X

Front Fender







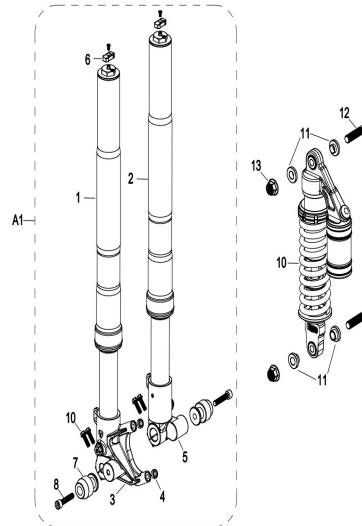

N°	Ref.	Description	Français	Picture	Qty/Bike	Model	GP187	GP157	GP107
1	YC110-0302-01-BKM	MINI GP ABS front fender Black MAT	Garde boue avant ABS MINI GP Noir MAT		1	GP107 GP157 GP187	X	X	X
2	YC110-0307-SI	MINI GP Aluminium Front Fender left Support SILVER MAT	Support Aluminium de garde boue boue avant gauche MINI GP SILVER MAT		1	GP107 GP157 GP187	X	X	X
3	YC110-0308-SI	MINI GP Aluminium Front Fender right Support SILVER MAT	Support Aluminium de garde boue boue avant droit MINI GP SILVER MAT		1	GP107 GP157 GP187	X	X	X

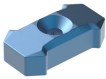

4	YC110-1446-10	Rear clay plate mounting bushing Aluminum d12mmxd6.1mmxd8mmx3.4mm Step d6.1mmxd8mmx2.4mm matte black	Bague de montage de plaque d'argile arrière aluminium d12mmxd6.1mmxd8mmx3.4mm step d6.1mmxd8mmx2.4mm mat noir		4	GP107 GP157 GP187	X	X	X
5	BT08-M6x20-W	Hex.Bolt M6x20mm for front fender support	Vis M6x20mm pour support de garde boue avant		4	ALL BIKES 20	X	X	X
6	GB70-M6x12	Stud screw M6x12mm for MINI GP front mudguard	Vis M6x12mm fixation garde boue avant MINI GP		4	ALL BIKES 20	X	X	X

Front & Rear absorber



N°	Ref.	Description	Français	Picture	Qty/Bike	Model	GP187	GP157	GP107
A1	YC110-0400-44-TI	MINI GP Pair of fork ZL L=650mm Adjustable compression / Rebound Titanium	Jeu de fourche ZL MINI GP L=650mm réglable compression / détente Titane		1	GP157 GP187	X	X	
A1	YC110-0400-45-TI	MINI GP Pair of fork LY L=650mm Not Adjustable Titanium	Jeu de fourche LY MINI GP L=650mm NON réglable Titane		1	GP107			X



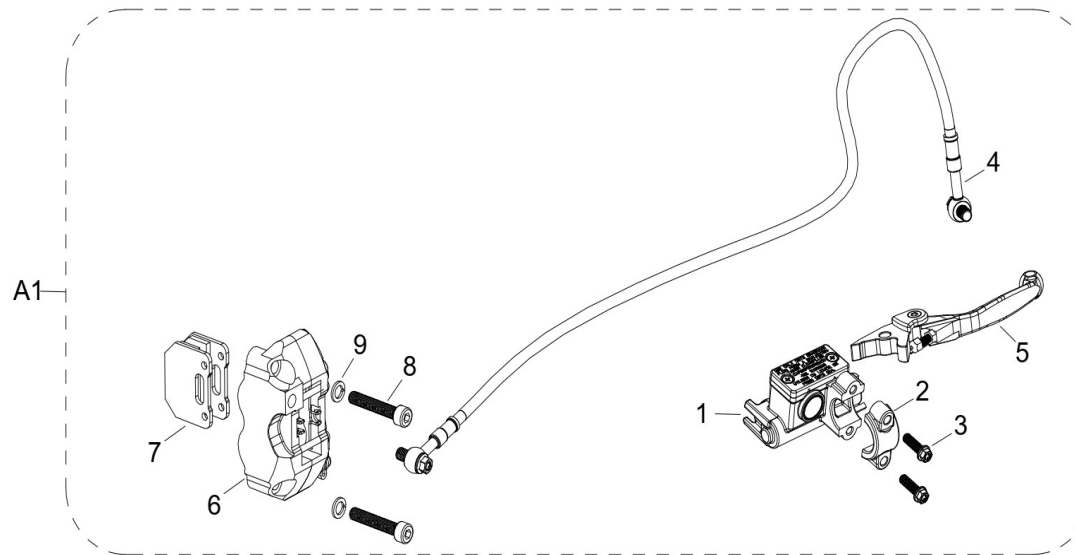

6	YC110-0442	Manual adjustment knob aluminum	Bouton de réglage manuel aluminium		2	GP157 GP187	X	X	
7	YC110-1035-02-BKM	MINI GP Front / Rear Spool Teflon MATT Black	Diabolo MINI GP Teflon noir mat		2	GP107 GP157 GP187	X	X	X
8	GB70-M8x40	Hexagonal Head Bolt with half thread M8x40mm For front spool	Vis Allen (BTR) M8x40mm pour fixation diabolo		2	ALL BIKES 12	X	X	X
9	BT08-M6x20-W	Hex.Bolt M6x20mm for clamp	Vis M6x20mm pourXXX		4	ALL BIKES 20	X	X	X
10	YC110-0404-97	Shock absorber 310mm 1000lbs DNM Black / White	Amortisseur DNM 310mmx1000lbs Noir / Blanc		1	GP187	X		
10	YC110-0404-98	Shock absorber PILOT 310mmx800lbs ZL YELLOW	Amortisseur PILOT 310mmx800lbs ZL JAUNE		1	GP157		X	
10	YC110-0404-17	Shock absorber PILOT 310mmx800lbs YELLOW	Amortisseur PILOT 310mmx800lbs JAUNE		1	GP107			X
11	YC110-0427-03	Shock bottom spacer d12mmxd17mmx19.5x6mm T=3	Entretoise amortisseur pour bras mono d12mmxd17mmx19.5x6mm T=3		4	GP187	X		
11	YC110-0419-03	Shock bottom spacer ENGI d12mmxd14mmx6x11mm	Entretoise amortisseur pour bras mono ENGI d12mmxd14mmx6x11mm		4	GP157		X	
11	YC110-0420	Shock bottom spacer d12mmxd16mmxd20mmx10.9mm T=3mm (same for top/bottom) LB	Entretoise amortisseur bas d12mmxd16mmxd20mmx10.9mm T=3mm pour bras mono LB		4	GP107			X

12	GB5787-M12x60-W	Hex. Bolt with flanged M12x60mm for shock absorber fixation top and bottom	Vis M12x60mm pour fixation amortisseur haut et bas		2	GP107 GP157 GP187	X	X	X
13	GB6187-M12-W	Self-locking Nut M12 for shock absorber fixation screw	Ecrou M12 pour vis fixation amortisseur		2	GP107 GP157 GP187	X	X	X

Front Brake Assy



N°	Ref.	Description	Français	Picture	Qty/Bike	Model	GP187	GP157	GP107
A1	YC110-0512-10	MINI GP Radial Front brake assy 2 pumps L=775mm 2014 Black	Kit frein avant Radial 2 pistons avec gaine plastic noire L=775mm Noir		1	GP107 GP157 GP187	X	X	X
4	YC110-0504-04	Radial Front brake steel line L=775mm d10mm/d10mm Black	Durite frein avant Radial L=775mm d10mm/d10mm Noire		1	GP107 GP157 GP187	X	X	X
5	LFP-21-SI	FOLDABLE BRAKE LEVER 21 CNC Silver	LEVIER FREIN PLIABLE 21 CNC Silver		1	GP107 GP157 GP187	X	X	X

6	YC110-0502-06-BK	Front Brake caliper 2014 BLACK	ETRIER FREIN AVANT RADIAL		1	GP107 GP157 GP187	X	X	X
7	YC110-0506-01	Front Brake pads 2014	JEU PLAQUETTE FREIN AVANT RADIAL 2014		2	GP107 GP157 GP187	X	X	X
8	GB70-M8x45	HEXAGON SOCKET Head Bolt M8x45mm	Vis Allen (BTR) M8x45mm		2	GP107 GP157 GP187	X	X	X
9	GB93-d8-W	Spring Lock Washers d8mm	Rondelle a ressort d8mm		2	GP107 GP157 GP187	X	X	X

Front Wheel Assy

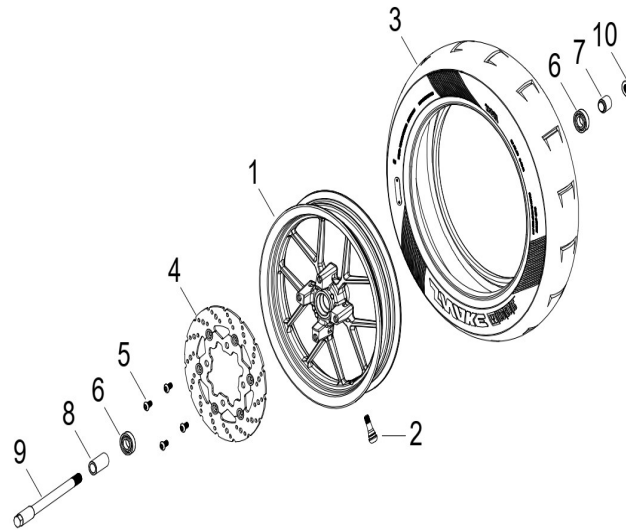







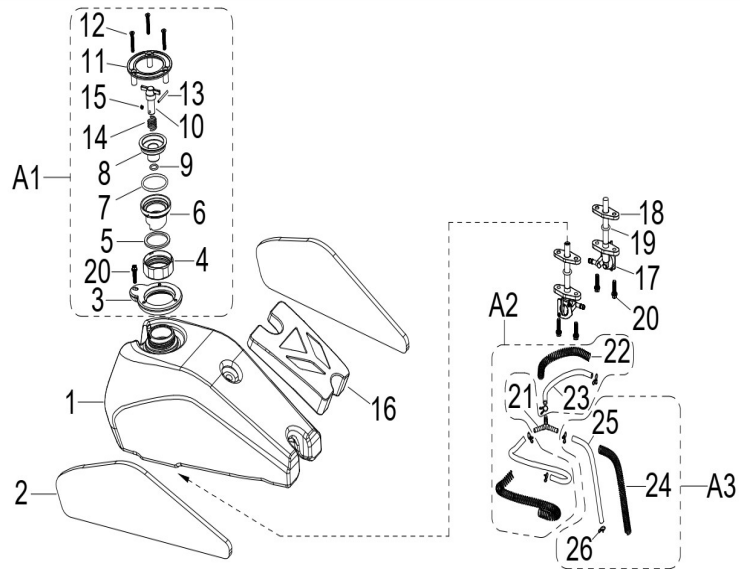





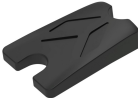

N°	Ref.	Description	Français	Picture	Qty/Bike	Model	GP187	GP157	GP107
1	YC110-0602-09-BK	YCF SM front rim 2.15x12' 2020 (without disk) Black	Roue avant SM YCF 2.15x12' (sans disque) 2020 Noire		1	SM GP107 GP157 GP187	X	X	X

2	TR413	Inner tire valve for SM rims	Valve pour jantes SM		1	SM GP107 GP157 GP187	X	X	X
3	K702-110/70-12'	KENDA SM Tire 110/70/12'	Pneu KENDA SM 110/70/12'		1	SM GP107 GP157 GP187	X	X	X
4	YC110-0613-02-GY	YCF Semi floating brake disk d220mm GREY	Disque frein avant flottant d220mm GREY		1	GP107 GP157 GP187	X	X	X
5	GB70.2-M8x25-4	Hex. Bolt M8x25mm (STEP d9.8mmx3.5mm) FOR Semi floating disk	Vis M8x25mm (STEP d9.8mmx3.5mm) pour fixation disque flottant		4	GP107 GP157 GP187	X	X	X
6	6202-NTN	NTN Ball bearing 6202 35mmxd15mmx11mm	Roulement roue 6202 NTNd35mmxd15mmx11mm		2	GP107 GP157 GP187	X	X	X
7	YC110-06-047	Front wheel spacer right d15mmxd22mmx23mm with STEP d19.5mmx4mm	entretoise roue avant droite d15mmxd22mmx23mm avec epaulement d19.5mmx4mm		1	GP107 GP157 GP187	X	X	X
8	YC110-06-044	Front wheel spacer lift d15mmxd22mmx28mm	Entretoise roue avant gauched15mmx22mmx28mm		1	GP107 GP157 GP187	X	X	X
9	YC110-06-062	MINI GP front axle L=215mm with holes with Self-locking nut M14	Axe de roue avant MINI GP L=215mm perces avec ecrou M14		1	GP107 GP157 GP187	X	X	X
10	GB6187-M14-W	Self-locking nut M14 for front wheel axle	Ecrou axe roue avant M14		1	GP107 GP157 GP187	X	X	X

Fuel Tank









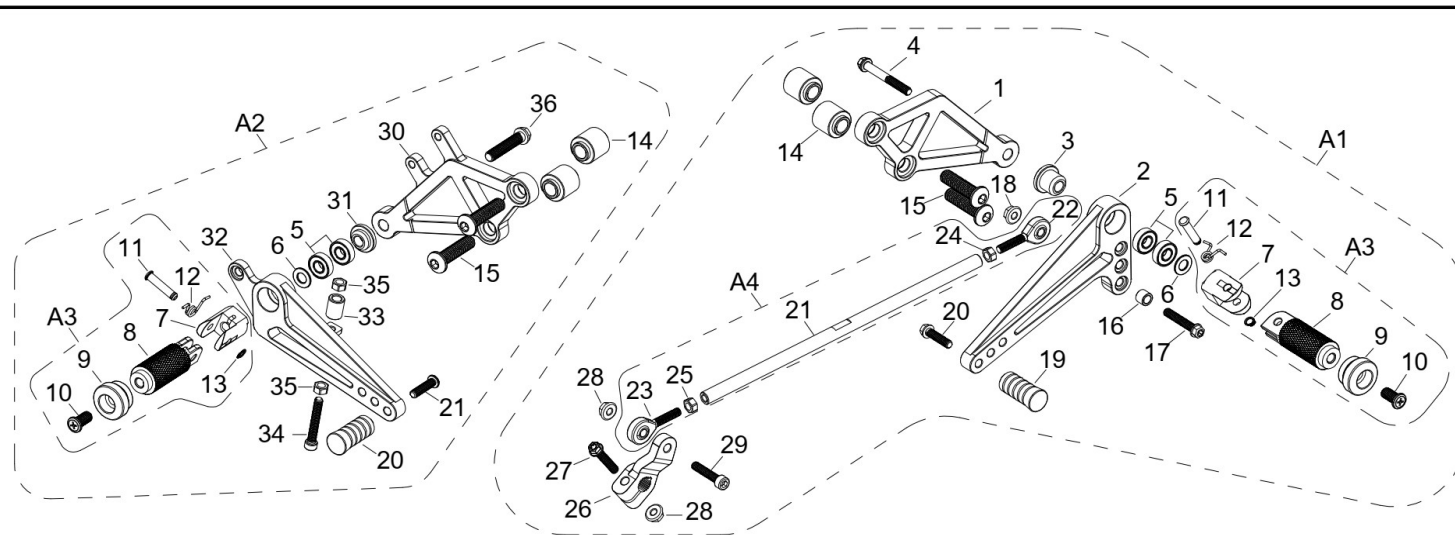







N°	Ref.	Description	Français	Picture	Qty/Bike	Model	GP187	GP157	GP107
1	YC110-0701-08	Fuel tank FLAT TRACK Black 2020	Reservoir FLAT TRACK Noir 2020		1	GP107 GP157 GP187	X	X	X
2	YC110-0729-02	Sponge of Fuel tank outer cladding FLAT TRACK 2020	Coton de mer Couvre reservoir FLAT TRACK 2020		2	GP107 GP157 GP187	X	X	X
A1	YC110-0721	MINI GP Aluminium quick release gas cap	Bouchon reservoir rapide complet Aluminium MINI GP		1	GP107 GP157 GP187	X	X	X
12	GB70.3-M5x30	MINI GP screw M5x30mm for support quick release gas cap	Vis M5x30mm pour support bouchon reservoir rapide		3	GP107 GP157 GP187	X	X	X
16	YC110-0729-04	MINI GP rubber wedge between gas tank and bas cover	Cale caoutchouc entre reservoir et couvre reservoir MINI GP		1	GP107 GP157 GP187	X	X	X











17	YC110-0703	Fuel cock assy.	robinet essence		2	GP107 GP157 GP187	X	X	X
18	YC110-0743	Fuel tank switch pad H=10mm	Réservoir switch pad H=10mm		2	GP107 GP157 GP187	X	X	X
19	YC110-0717-03	O-RING,d10.8mmx2.65mm For Fuel cock assy	Joint Thorique d10.8mmx2.65mm pour robinet essence		2	GP107 GP157 GP187	X	X	X
20	BT08-M6x20-W	HEXAGON Torx screw with Flange M6x20mm	Vis HEXAGONALE Torx avec Flange M6x20mm		5	GP107 GP157 GP187	X	X	X
21	YC110-0723-01	Flat Track Fuel cock assy. CONNEXION	CONNEXION Robinet essence FLAT TRACK		1	GP107 GP157 GP187	X	X	X
A2	YC110-07060	fuel tank rubber line spring d4.5mmxd8.5mmx90mm	durite reservoir avec ressort d4.5mmxd8.5mmx90mm		7	GP107 GP157 GP187	X	X	X
23	YC110-07062-02	fuel tank rubber line d4.5mmxd8.5mmx90mm	durite reservoir d4.5mmxd8.5mmx90mm		2	GP107 GP157 GP187	X	X	X
A3	YC110-07060-02	fuel tank rubber line spring d4.5mmxd8.5mmx185mm	durite reservoir avec ressort d4.5mmxd8.5mmx185mm		1	GP107 GP157 GP187	X	X	X
25	YC110-07062-01	fuel tank rubber line d4.5mmxd8.5mmx185mm	durite reservoir d4.5mmxd8.5mmx185mm		1	GP107 GP157 GP187	X	X	X



Foot Peg assy



N°	Ref.	Description	Français	Picture	Qty/Bike	Model	GP187	GP157	GP107
A1	YC110-0933-L	Complete left Reaset	Commandes reculees complete gauche		1	GP107 GP157 GP187	X	X	X
A2	YC110-0935-R	Complete right Reaset	Commandes reculees complete droite		1	GP107 GP157 GP187	X	X	X
1	YC110-0933-SI	MINI GP left aluminium footpeg support SILVER	Platine aluminium support de repose pied gauche MINI GP SILVER		1	GP107 GP157 GP187	X	X	X
2	YC110-0934-SI	MINI GP aluminium gearshift pedall SILVER	Platine selecteur aluminium MINI GP SILVER		1	GP107 GP157 GP187	X	X	X
3	YC110-1446-06-SI	MINI GP aluminium spacer for gearshift pedall d22mmxd8.2mmxd16mmx17mm 台阶: d8.2mmxd16mmx13.5mm SILVER	Entretoise pour selecteur aluminium MINI GP d22mmxd8.2mmxd16mmx17mm 台阶: d8.2mmxd16mmx13.5mm SILVER		1	GP107 GP157 GP187	X	X	X

4	BT08-M8x50-W	HEXAGON Torx screw with Flange M8x50mm	Vis HEXAGONALE Torx avec Flange M8x50mm		1	GP107 GP157 GP187	X	X	X
5	698ZZ	Beraring 698ZZ d19mmxd8mmx6mm for MINI GP gearshift pedal	Roulement 698ZZ d19mmxd8mmx6mm pour selecteur MINI GP		4	GP107 GP157 GP187	X	X	X
6	95-0800ZZ	Washer d8mmx16mmx2mm	Rondelle d8mmx16mmx2mm		2	GP107 GP157 GP187	X	X	X
A3	YC110-0902-18-SI	MINI GP complete aluminium right / Left footpegs with POM end cap SILVER	Repose pied complet droit / gauche MINI GP avec embout Teflon SILVER		2	GP107 GP157 GP187	X	X	X
7	YC110-1035-SI	MINI GP aluminium supoport for right / Left footpegs SILVER	Support repose pied droit / gauche MINI GP SILVER		2	GP107 GP157 GP187	X	X	X
8	YC110-1036-SI	MINI GP aluminium main part for right / Left footpegs SILVER	Partie centrale repose pied droit / gauche MINI GP SILVER		2	GP107 GP157 GP187	X	X	X
9	YC110-1037-BKM	MINI GP POM end cap part for right / Left footpegs Black	Partie embout teflon repose pied droit / gauche MINI GP Noire		2	GP107 GP157 GP187	X	X	X
10	GB70.2-M8x16	Screw M8x16mm for brake disk	vis M8x20mm pour disque de frein		2	GP107 GP157 GP187	X	X	X
11	GB882-d6x21	Shaft pin inox for MINI GP footpegs d6mmx21mm	Axe repose pied inox d6mmx21mm		2	GP107 GP157 GP187	X	X	X
12	YC110-09-05	Spring for MINI GP foot peg d1.5mmxd7mmxd10mmx32mm	Ressort repose pied MINI GP gauche inox d1.5mmxd7mmxd10mmx32mm		2	GP107 GP157 GP187	X	X	X



13	YC110-2607-03	Clip spring d5mm	Clip d5mm		2	GP107 GP157 GP187	X	X	X
14	FB13-d22xd8x3.5-BKM	MINI GP aluminium spacer d22xd8x3.5mm (d16x8x4.5mm) for gearshift MATT BLACK	Entretoise aluminium d22xd8x3.5mm (epaulement d16x8x4.5mm) pour selecteur MINI GP NOIR MAT		4	GP107 GP157 GP187	X	X	X
15	GB70.2-M10x40	Pan head hexagon screwM10x40mm	Vis à tête ronde Allen (BTR) M10x40mm		4	GP107 GP157 GP187	X	X	X
16	FB13-7x12x5.5	Bushing d7mmd12mmd5.5mm for Chain box protection	Entretoise d7mmd12mmd5.5mm pour Protection chaine plastique		1	GP107 GP157 GP187	X	X	X
17	BT08-M6x35-W	Screw M6x35mm	Vis M6x35mm		1	GP107 GP157 GP187	X	X	X
18	GB6187-M6-W	HEXAGON FLAT FLANGE LOCK NUT M6mm	Ecrou HEXAGONAL avec Flange autobloquant M6mm		1	GP107 GP157 GP187	X	X	X
19	YC110-0903-11	MINI GP POM gearshift end cap d16x37	Embout selecteur POM d16x37 MINI GP		2	GP107 GP157 GP187	X	X	X
20	BT08-M6x25-W	Screw M6x25mm	Vis M6x25mm		2	GP107 GP157 GP187	X	X	X
A4	YC110-0928-MG	MINI GP aluminium complete gearshift tube Magnesium	Tige selecteur complete aluminium MINI GP Magnesium		1	GP107 GP157 GP187	X	X	X
21	YC110-0931-SI	MINI GP aluminium gearshift tube M6x263mm SILVER	Tige selecteur aluminium MINI GP M6x263mm SILVER		1	GP107 GP157 GP187	X	X	X

22	YC110-0939-01	Bearing for gearshift tube M6	Rotule tige selecteur MINI GP M6		1	GP107 GP157 GP187	X	X	X
23	YC110-0939-02	Bearing for gearshift tube M6	Rotule tige selecteur MINI GP M6		1	GP107 GP157 GP187	X	X	X
24	GB6170-M6-W-LH	Hexagonal Nut M6	Ecrou hexagonal M6		1	GP107 GP157 GP187	X	X	X
25	GB6170-M6-W-H	Hexagonal Nut M6	Ecrou hexagonal M6		1	GP107 GP157 GP187	X	X	X
26	YC110-0932-SI	MINI GP aluminium gearshift sixation SILVER	Maintient de tige de selecteur aluminium MINI GP SILVER		1	GP107 GP157 GP187	X	X	X
27	BT08-M6x30-W	Screw M6x30mm	Vis M6x30mm		1	GP107 GP157 GP187	X	X	X
28	GB6187-M6-W	HEXAGON FLAT FLANGE LOCK NUT M6mm	Ecrou HEXAGONAL avec Flange autobloquant M6mm		2	GP107 GP157 GP187	X	X	X
29	GB70-M6x25	Hexagonal Head Bolt with half thread M6x25mm For front spool	Vis Allen (BTR) M8x25mm pour fixation diabolo		1	GP107 GP157 GP187	X	X	X
30	YC110-0935-SI	MINI GP right aluminium footpeg support SILVER	Platine aluminium support de repose pied droite MINI GP SILVER		1	GP107 GP157 GP187	X	X	X
31	FB13-d22xd6x14.5 -SI	MINI GP aluminium gearshift pedall SILVER	Platine selecteur aluminium MINI GP SILVER		1	GP107 GP157 GP187	X	X	X

32	YC110-0938-SI	MINI GP aluminium spacer for gearshift pedall SILVER	Entretoise pour selecteur aluminium MINI GP SILVER		1	GP107 GP157 GP187	X	X	X
33	YC110-8801-01	Bushing Aluminum d12mmxd7mmx16mm	Bague aluminium d12mmxd7mmx16mm		1	GP107 GP157 GP187	X	X	X
34	GB70-M6x50	Hexagonal Head Bolt with half thread M6x50mm For front spool	Vis Allen (BTR) M8x50mm pour fixation diablo		1	GP107 GP157 GP187	X	X	X
35	GB6170-M6-W-H	Hexagonal Nut M6	Ecrou hexagonal M6		2	GP107 GP157 GP187	X	X	X
36	BT08-M8x40-W	HEXAGON Torx screw with Flange M8x45mm	Vis HEXAGONALE Torx avec Flange M8x45mm		1	GP107 GP157 GP187	X	X	X

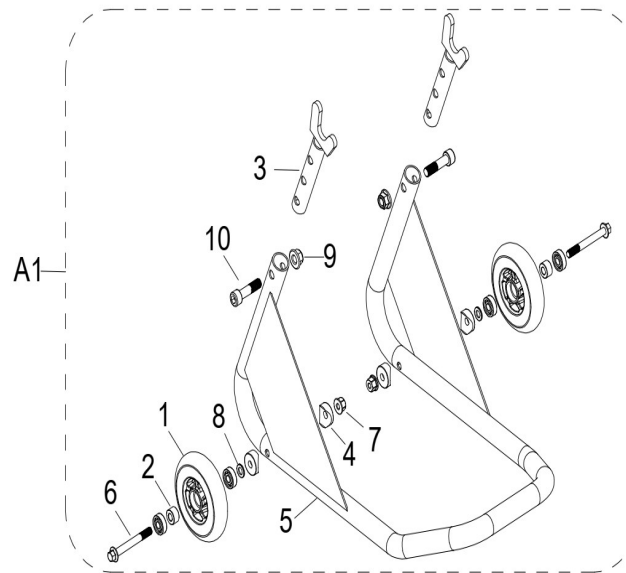

Foot Peg Assy





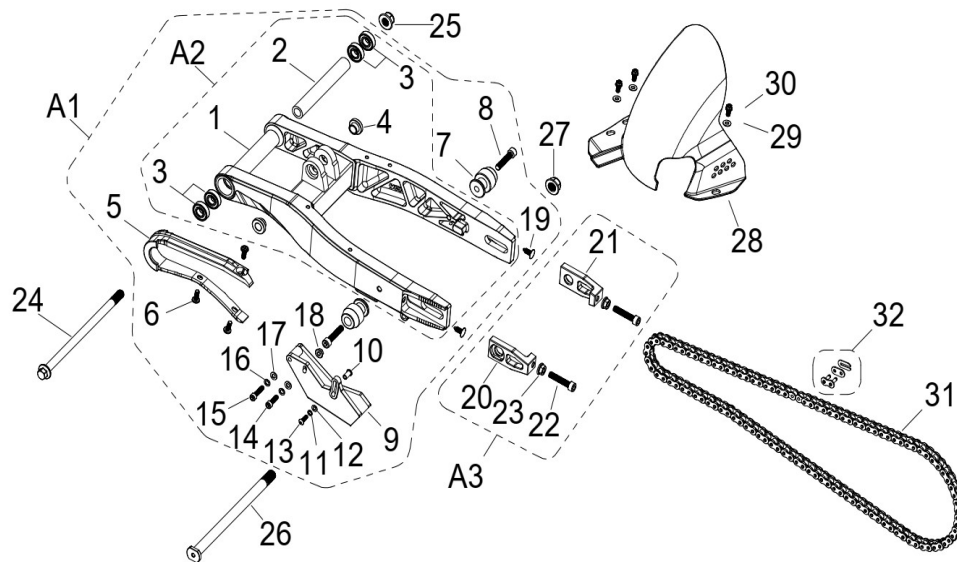













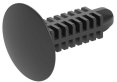



N°	Ref.	Description	Français	Picture	Qty/Bike	Model	GP187	GP157	GP107
A1	STAND1MOTO-04	Stand SM for spools with small wheels Black	Bequille ajustable SM pour diablo avec roulette Noire		1	GP107 GP157 GP187	X	X	X
1	STAND1MOTO-0401	Wheel for stand SM for spools with small wheels Black	Roulette pour bequille ajustable SM pour diablo avec roulette Noire		2	GP107 GP157 GP187	X	X	X

Swing Arm assy



N°	Ref.	Description	Français	Picture	Qty/Bike	Model	GP187	GP157	GP107
A1	YC110-10-01	Complete MINIGP Mono swing arm YCF Aluminium 420 mm d12mm (173 mm)	Bras oscillant mono Aluminium Complet MINIGP YCF 420mm d12mm (173 mm)		1	GP107 GP157 GP187	X	X	X
A2	YC110-10015-02	Mono swing arm YCF Aluminium 420mm 2020 d12mm (173 mm)	Bras oscillant mono YCF Aluminium 420mm 2020 d12mm (173 mm)		1	GP107 GP157 GP187	X	X	X



2	YC110-1007-11	Central spacer swing arm Aluminium SP d13mmxd20mmx141mm	Entretoise centrale de bras oscillent SP d13mmxd20mmx141mm		1	SP2202 SP322 GP107 GP157 GP187	X	X	X
3	6001	NTN Bearingfor swing arm d12mm	Roulement bras oscillent NTN d12mm		4	SP2202 SP322 GP107 GP157 GP187	X	X	X
4	YC110-1001-021	Sleeve for swing arm d12mmxd16mmxd24mmx10mm	Entretoise bras oscillant/amorto d12mmxd16mmxd24mmx10mm		2	GP107 GP157 GP187	X	X	X
5	YC110-10-026	Chain slider YCF Aluminium swing arm 420mm PU	Patin chaine YCF long pour Bras oscillent Aluninium YCF 420mm PU		1	GP107 GP157 GP187	X	X	X
6	DIN7985-M6x16	Screw M6x16mm for Rear brake hose guide	Vis M8x16mm pour Passe durite de bras oscillant		3	GP107 GP157 GP187	X	X	X
7	YC110-1035-02-BKM	MINI GP Spool Teflon MATT Black	Diabolo MINI GP Teflon Noir MAT		2	GP107 GP157 GP187	X	X	X
8	GB70-M8x40	Hexagonal Head Bolt with half thread M8x40mm For front spool	Vis Allen (BTR) M8x40mm pour fixation diabolo		2	GP107 GP157 GP187	X	X	X
9	YC110-1004-01	YCF chain guide assy for High class range Black	Guide chaine YCF pour haut de gamme Noir		1	GP107 GP157 GP187	X	X	X
19	YC110-1607-03	Plastic cap for swing arm thread	Caps pour pas de vis tendeur de chaine bras oscillent		2	GP107 GP157 GP187	X	X	X
A3	YC110-1021-GY	MINI GP complete Block axle GREY	Jeu tendeur chaine complet MINI GP GREY		1	GP107 GP157 GP187	X	X	X





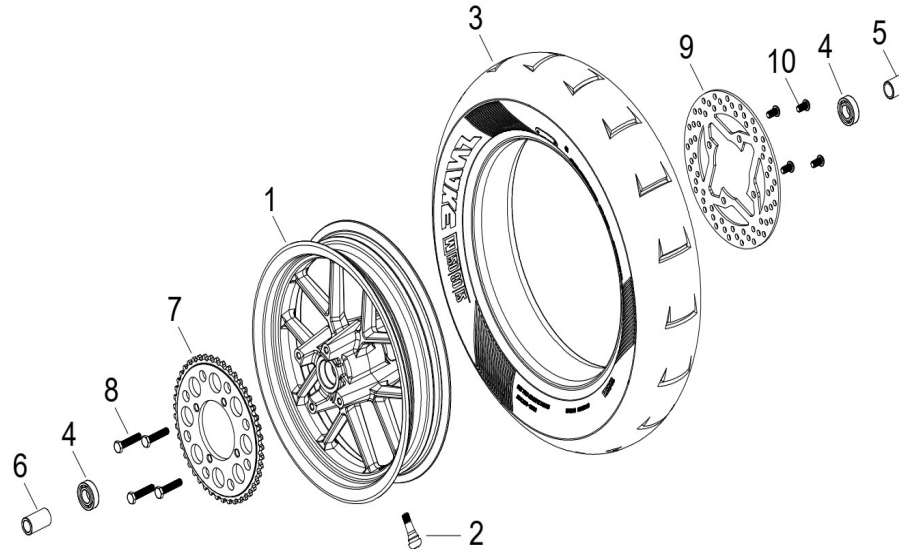

22	GB70-M8x40	HEXAGON SOCKET Head Bolt M8x40mm	Vis Allen (BTR) M8x40mm		2	GP107 GP157 GP187	X	X	X
23	FB6170-M8-W	Hexagonal Nut M8	Ecrou tendeur chaine M8		2	GP107 GP157 GP187	X	X	X
24	YC110-10-033	Swing arm shaft L=236mm	axe bras oscillant d3 L=236mm		1	GP107 GP157 GP187	X	X	X
25	GB6187-M12-W	Self locking nut M12	Ecrou bras oscillant M12		1	GP107 GP157 GP187	X	X	X
26	YC110-1011	MINI GP rear wheel Axle L=230mm with holes with Self-locking nut M14	Axe de roue arriere MINI GP L=230mm perces avec ecrou M14		1	GP107 GP157 GP187	X	X	X
27	GB6187-M14-W	Self locking nut M14	Ecrou axe roue arriere M14		1	GP107 GP157 GP187	X	X	X
28	YC110-0460-02-BKM	MINI GP ABS rear fender MATT Black	Garde boue arriere ABS MINI GP Noir MAT		1	GP107 GP157 GP187	X	X	X
29	YC110-1446-10	Rear clay plate mounting bushing aluminum d12mmxd6.1mmxd8mmx3.4mm Step: d6.1mmxd8mmx2.4mm	Bague de montage de plaque d'argile arriere aluminium d12mmxd6.1mmxd8mmx3.4mm step: d6.1mmxd8mmx2.4mm		3	GP107 GP157 GP187	X	X	X
30	BT08-M6x12-W	Hexagonal Bolt M6x12mm for rear fender	Vis M6x12mm pour garde boue arriere		3	GP107 GP157 GP187	X	X	X
31	420DX-108T	Chain 420DX-108T extra strong	Chaîne 420 108 maillons renforcee		1	GP107 GP157 GP187	X	X	X

32	AR-420KMC	Chain link H=17mm KMC	Attache rapide chaine H=17mm KMC		1	GP107 GP157 GP187	X	X	X
----	-----------	-----------------------	----------------------------------	---	---	-------------------------	---	---	---





Rear Wheel Assy



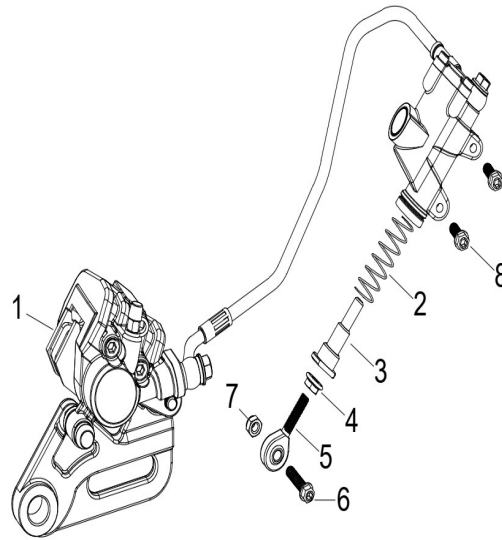

N°	Ref.	Description	Français	Picture	Qty/Bike	Model	GP187	GP157	GP107
1	YC110-0626-02-BK	YCF SM rear rim 2.75x12' 2020 (without disk) Black	Roue arriere SM YCF 2.75x12' (sans disque) 2020 Noire		1	SM GP107 GP157 GP187	X	X	X
2	TR413	Inner tire valve for SM rims	Valve pour jantes SM		1	SM GP107 GP157 GP187	X	X	X
3	K702-120/70-12'	KENDA SM Tire 120/70/12'	Pneu KENDA SM 120/70/12'		1	SM GP107 GP157 GP187	X	X	X

4	6202-NTN	NTN Ball bearing 6202 35mmxd15mmx11mm	Roulement roue 6202 NTNd35mmxd15mmx11mm		2	GP107 GP157 GP187	X	X	X
5	YC110-11-041	Rear wheel spacer right d15mmxd22mmx29mm	Entretoise roue arriere droite d15mmxd22mmx29mm		1	SM GP107 GP157 GP187	X	X	X
6	YC110-11-052	Rear wheel spacer left d15mmxd22mmx38mm	Entretoise roue arriere gauche d15mmxd22mmx38mm		1	SM GP107 GP157 GP187	X	X	X
7	YC110-11-06/41	YCF Driven sprocket 420-41T (4 holes)	couronne acier 420-41T YCF (4 trous)		1	SM GP107 GP157 GP187	X	X	X
8	GB5783-M8x25-W	Hex. Bolt M8x25mm for rear sprocket fixation	Vis M8x25mm pour fixation couronne		4	GP107 GP157 GP187	X	X	X
9	YC110-1115-04	Flat Track Rear Brake disc d200mm	Disque frein arriere d200mm FLAT TRACK		1	FLAT TRACK GP107 GP157 GP187	X	X	X
10	GB70.2-M8x20	Screw M8x20mm for brake disk	vis M8x20mm pour disque de frein		4	GP107 GP157 GP187	X	X	X
REAR BRAKE									









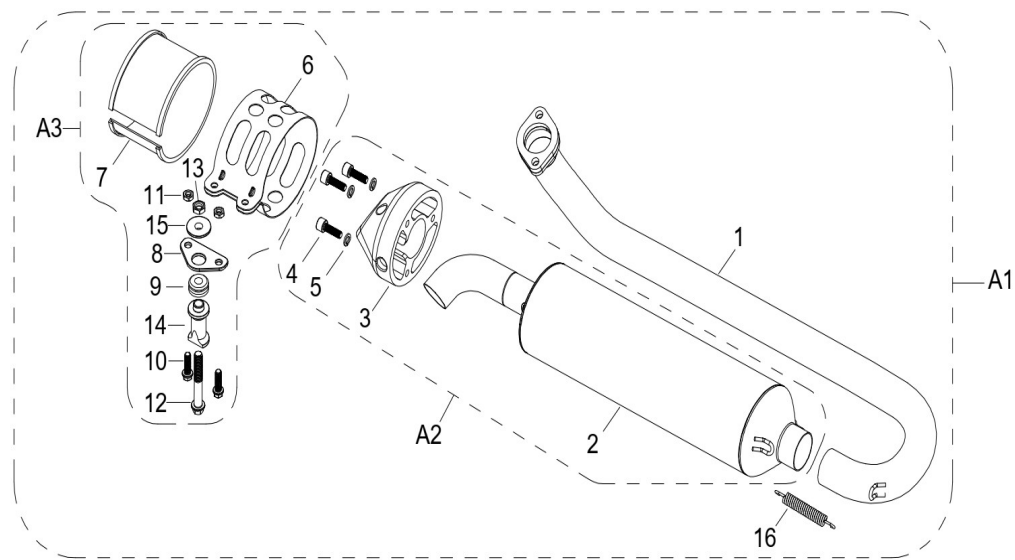



N°	Ref.	Description	Français	Picture	Qty/Bike	Model	GP187	GP157	GP107
1	YC110-1212-09	MINI GP rear brake assy d10/10 L=365mm	Kit frein arriere MINI GP d10/10 L=365mm		1	GP107 GP157 GP187	X	X	X
2	YC110-1257-01	Rear brake pump top rod spring d2mmxd14mmxd18mmx30mm	Ressort de barre supérieure de pompe de frein arrière d2mmxd14mmxd18mmx30mm		1	GP107 GP157 GP187	X	X	X
3	YC110-0936-SI	MINI GP push stick for rear brake SILVER	Tige poussoir frein arriere MINI GP SILVER		1	GP107 GP157 GP187	X	X	X
4	GB6177-M6-W	Hexagonal Flanged nut M6	Ecrou M6		1	GP107 GP157 GP187	X	X	X
5	YC110-0937	Bearing for rear brake push stick	Roulement pour tige poussoir frein arriere MINI GP		1	GP107 GP157 GP187	X	X	X

6	BT08-M6x25-W	Screw M6x25mm for rear brake assy	Vis M6x25mm pour Kit frein arriere		1	GP107 GP157 GP187	X	X	X
7	GB6184-M6-W	HEXAGON FLAT NYLON LOCK NUT M6	Ecrou HEXAGONAL autobloquant nylon M6		1	GP107 GP157 GP187	X	X	X
8	BT08-M6x20-W	HEXAGON Torx screw with Flange M6x20mm	Vis HEXAGONALE Torx avec Flange M6x20mm		2	GP107 GP157 GP187	X	X	X

Exhaust system



N°	Ref.	Description	Français	Picture	Qty/Bike	Model	GP187	GP157	GP107
A1	YC110-13-01	Complete MINIGP Single Racing Muffler & Exhaust 2023 GP157 / GP187	Echappement complet MINIGP 2023 GP157 / GP 187		1	GP157 GP187	X	X	







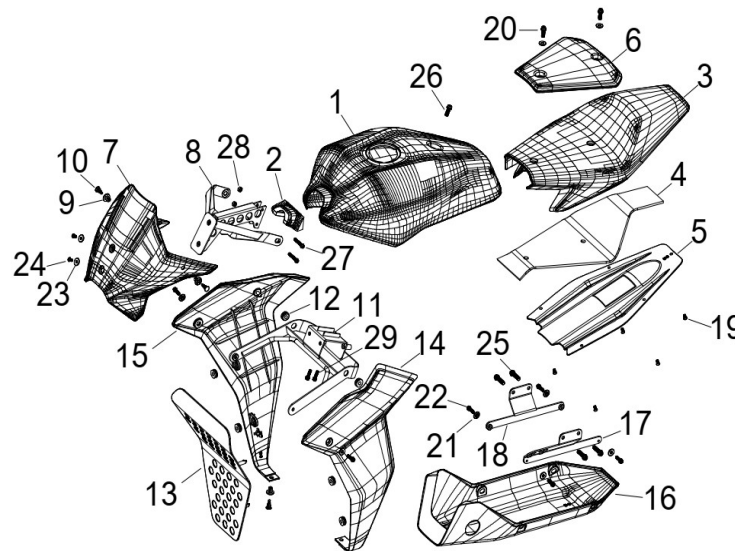

A1	YC110-13-02	Complete MINIGP Single Racing Muffler & Exhaust 2023 GP107	Echappement complet MINIGP 2023 GP107		1	GP107			X
1	YC110-1302-40	MINI GP belly exhaust pipe	Collecteur MINI GP sous cadre		1	GP107 GP157 GP187	X	X	X
A2	YC110-13014-0201-GY	YCF Muffler FLATTRACK (2 springs) GREY GP157/GP187	Silencieux YCF FLATTRACK (2 ressorts) GRIS GP157/GP187		1	GP157 GP187	X	X	
A2	YC110-13014-0202-GY	YCF Muffler FLATTRACK (2 springs) GREY GP 107	silencieux YCF FLATTRACK (2 ressorts) GRIS GP107		1	GP107			X
3	YC110-13-35	Muffler end cap SPII	Embout silencieux racing SPII		1	GP107 GP157 GP187	X	X	X
4	GB70-M5x16	Screw M5x16mm for muffler end cap	Vis M5x16mm pour Emout silencieux		3	GP107 GP157 GP187	X	X	X
5	GB93-d5	Standard spring washer d5mm for muffler end cap	Rondelle d5mm pour Embout silencieux		3	GP107 GP157 GP187	X	X	X
A3	YC110-1307-03	MINI GP hoop for muffler YCF (with FB13-8x14x35-W 1EA+GB5787-M8x60-W 1EA)	Attache silencieux MINI GP		1	GP107 GP157 GP187	X	X	X
11	GB6177-M6-W	Hexagonal Flanged nut M6	Ecrou M6		2	GP107 GP157 GP187	X	X	X
12	BT08-M8x60-W	Hexagonal Bolt M8x60mm	Vis M8x60mm		1	GP107 GP157 GP187	X	X	X





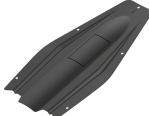





13	GB6177-M8-W	Hexagonal Flanged nut M8	Ecrou M8		1	GP107 GP157 GP187	X	X	X
14	YC110-1321-03	Muffler Hoop spacer d8.2mmxd22mmxd15mmx35mm (step d8.2mmxd11mmx5mm)	Entretoise d8.2mmxd22mmxd15mmx35mm (step d8.2mmxd11mmx5mm) pour fixation silencieux		1	GP107 GP157 GP187	X	X	X
15	YC110-1321-02	Washer for mufler hoop d8.2mmxd11mmxd25mmx6mm (step d82mmxd11mmx4mm)	Entretoise d8.2mmxd11mmxd25mmx6mm (step d82mmxd11mmx4mm) pour fixation silencieux		1	GP107 GP157 GP187	X	X	X
16	YC110-1310-01	muffler spring d2mmxd10mmx43mm	ressort pot d2mmxd10mmx43mm		1	GP107 GP157 GP187	X	X	X









Seat & Plastic kit





N°	Ref.	Description	Français	Picture	Qty/Bike	Model	GP187	GP157	GP107
1	YC110-1402-06-BKM	MINI GP gas tank cover ABS MATT Black	Couvre reservoir ABS MINI GP Noir MAT		1	GP107 GP157 GP187	X	X	X

2	YC110-0729-05	MINI GP rubber wedge between front gas tank and frame	Cale caoutchouc entre avant reservoir et cadre MINI GP		1	GP107 GP157 GP187	X	X	X
3	YC110-1402-07-OR	MINI GP rear seat ABS fairing Orange	Base de selle ABS MINI GP arriere Orange		1	GP187	X		
3	YC110-1402-07-YE	MINI GP rear seat ABS fairing Yellow	Base de selle ABS MINI GP arriere Jaune		1	GP157		X	
3	YC110-1402-07-GR	MINI GP rear seat ABS fairing Green	Base de selle ABS MINI GP arriere Vert		1	GP107			X
4	YC110-0700-13	MINI GP rear seat protection foam	Mousse de protection Base de selle MINI GP		1	GP107 GP157 GP187	X	X	X
5	YC110-1402-08-BKM	MINI GP rear wheel arch ABS Black	Passage de roue ABS MINI GP Noir		1	GP107 GP157 GP187	X	X	X
6	YC110-1401-19-BKM	MINI GP seat MATT Black	Selle MINI GP Noire MAT		1	GP107 GP157 GP187	X	X	X
7	YC110-0212-13-BKM	MINI GP front fairing Matt Black	Tete de fourche MINI GP Noire		1	GP107 GP157 GP187	X	X	X
8	YC110-0738-BKM	MINI GP steel front fairing support MATT Black	Support acier tete de fourche MINI GP Noire MAT		1	GP107 GP157 GP187	X	X	X
9	YC110-0931-01	Plastic screw femal part for MINI GP fairing Black	Vis plastique femelle pour carenage MINI GP Noire		3	GP107 GP157 GP187	X	X	X



10	YC110-0931-02	Plastic screw male part for MINI GP fairing Black	Vis plastique male pour carenage MINI GP Noire		3	GP107 GP157 GP187	X	X	X
11	YC110-1444-BKM	MINI GP front fairing steel support MATT Black	Support acier tete de fourche MINI GP Noir MAT		1	GP107 GP157 GP187	X	X	X
12	YC110-1404-01	Rubber d8.2mmxd20.2mmx9mm Black	Caoutchouc d8.2mmxd20.2mmx9mm Noir		6	GP107 GP157 GP187	X	X	X
13	YC110-1445-BKM	MINI GP front guard ABS MATT Black	Protection avant MINI GP ABS Noire MAT		1	GP107 GP157 GP187	X	X	X
14	YC110-1433-02-BKM	MINI GP left side fairing ABS MATT Black	Carenage avant gauche MINI GP ABS Noire MAT		1	GP107 GP157 GP187	X	X	X
15	YC110-1432-02-BKM	MINI GP right side fairing ABS MATT Black	Carenage avant droitMINI GP ABS Noire MAT		1	GP107 GP157 GP187	X	X	X
16	YC110-0905-04-BKM	MINI GP skid plate ABS Matt Black	Sabot moteur MINI GP ABS Noir mat		1	GP107 GP157 GP187	X	X	X
17	YC110-0929-BKM	MINI GP left steel skid plate support MATT Black	Support acier gauche sabotmoteurMINI GP Noir MAT		1	GP107 GP157 GP187	X	X	X
18	YC110-0930-BKM	MINI GP right steel skid plate support Matt Black	Support acier droit sabotmoteurMINI GP Noir mat		1	GP107 GP157 GP187	X	X	X
19	GB819-M5x12	Plus screw M5x12mm for Upper Throttle Body Housing Cover	Vis M5x12mm plastique du dessus poignée gaz		5	GP107 GP157 GP187	X	X	X





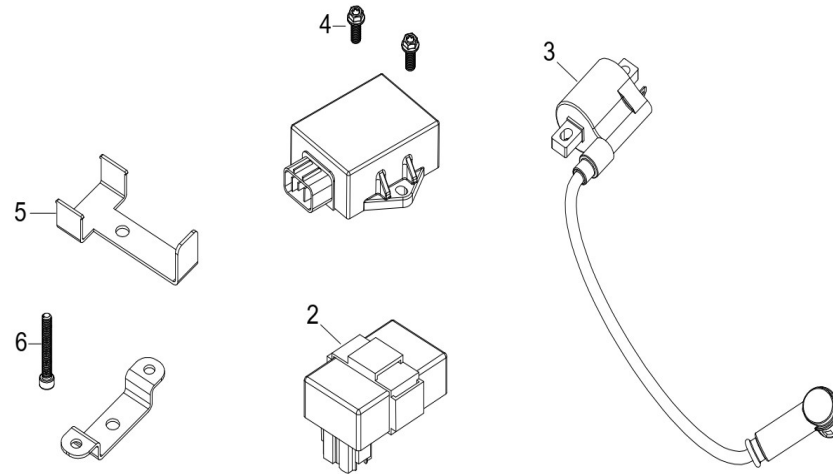



20	BT08-M6x16-W	Hexagonal Bolt M6x16mm	Vis M6x16mm		2	GP107 GP157 GP187	X	X	X
21	YC110-1446-02-BKM	Spacer M6 for front fairing fixation MATT Black	Entretoise M6 pour fixation tete de fourche Noir MAT		8	GP107 GP157 GP187	X	X	X
22	BT08-M6x12-W	Hexagonal Bolt M6x12mm for MINI GP skid plate fixation	Vis M6x12mm pour fixation sabot moteur MINI GP		6	GP107 GP157 GP187	X	X	X
23	YC110-1446-01-BK	Spacer M5 for front fairing fixation Black	Entretoise M5 pour fixation tete de fourche Noir		2	GP107 GP157 GP187	X	X	X
24	GB70.2-M5x12-Cr	Pan head hexagon screw M5x12mm	Vis à tête ronde Allen (BTR) M5x12mm		2	GP107 GP157 GP187	X	X	X
25	BT08-M8x30-W	Hexagonal Bolt M8x30mm	Vis M8x30mm		4	GP107 GP157 GP187	X	X	X
26	BT08-M8x20-W	Screw with Flange M8x20mm for gas tank fixation	Vis M8x20mm pour vfixation reservoir		1	GP107 GP157 GP187	X	X	X
27	BT08-M6x35-W	Hexagonal Bolt M6x35mm for MINI GP skid plate fixation	Vis M6x35mm pour fixation sabot moteur MINI GP		2	GP107 GP157 GP187	X	X	X
28	GB6187-M6-W	Self locking nut M6	Ecrou M6		2	GP107 GP157 GP187	X	X	X
29	BT08-M6x20-W	Hexagonal Bolt M6x20mm for MINI GP skid plate fixation	Vis M6x20mm pour fixation sabot moteur MINI GP		2	GP107 GP157 GP187	X	X	X

30	YC110-0702-03-SI	Bushing for fuel tank fixation d9mmxd22.5mmx7.5mm	Entretoise pour vis de fixation reservoir d9mmxd22.5mmx7.5mm		1	GP107 GP157 GP187	X	X	X
31	YC110-0717-02	O-ring for Gas Tank fixation kit Fuel tank d22.5mmxd12.5mmx2mm	Joint thorique Ecrou fixation reservoird22.5mmxd12.5mmx2mm		1	GP107 GP157 GP187	X	X	X





ELECTRIC



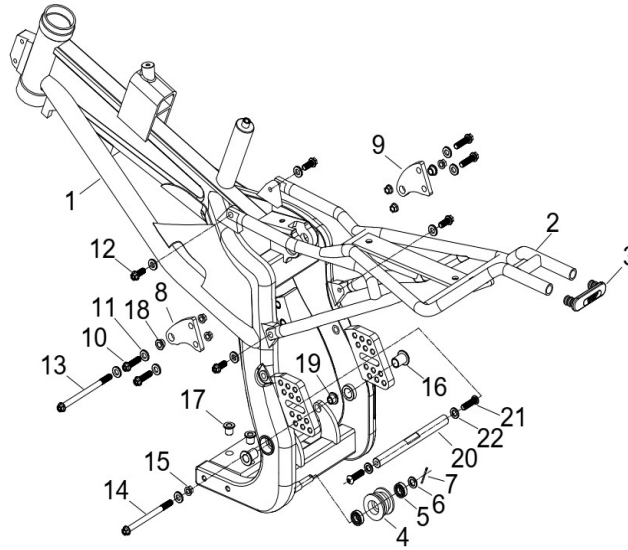













N°	Ref.	Description	Français	Picture	Qty/Bike	Model	GP187	GP157	GP107
1	86917	Wire harness for Daytona Anima FDX engine	Faisceaux électrique pour moteur Daytona Anima FDX		1	SP31322/ BFD1901 722/S187 1822/GP 187	X		
1	YC110-1501-01	Wire harness ZONGSHEN	FAISCEAUX ELECTRIQUE ZONGSHEN		1	W125-G W150-G W110-G GP157		X	
1	YC110-1501-22	Wire harness ZONGSHEN W125-G L=500mm	FAISCEAUX ELECTRIQUE ZONGSHEN W125-G L=500mm		1	LITE110 GP107			X

2	86427	Box, CDI for FDX, FLX Daytona engines	CDI pour moteur Anima FDX, FLX		1	SP31322/ BFD1901 722/S187 1822/GP 187	X		
2	100204339	C.di W125-G	CDI W125-G		1	W125-G W150-G W110-G GP157/G P107		X	X
3	86426	Coil, Ignition	Bobine d;allumage		1	GP187	X		
3	81100-1008-000050	IGNITION COIL MG03B L:500	Bobine d'allumage MG03B L:500		1	GP107 GP157		X	X
3	YC110-1505	anti interference red	anti parasite rouge		1	GP107 GP157 GP187	X	X	X
4	BT08-M6x16-W	Hexagonal Bolt M6x16mm	Vis M6x16mm		2	ALL BIKES 20	X	X	X
5	YC110-1540-02BK	CD1 Mounting Bracket Iron 87mmx46mmx28mm Matte Black	CD1 support de montage fer 87mmx46mmx28mm noir mat		1	GP187	X		
5	YC110-1540-01BK	CD1 Mounting support iron hole distance 73mm Matte black	CD1 support de montage trou de fer 73mm noir mat		1	GP157/G P107		X	X
6	GB70.2-M10x40	Pan head hexagon screwM10x40mm	Vis à tête ronde Allen (BTR) M10x40mm		1	GP107/GP 157/GP187	X	X	X
Frame									





N°	Ref.	Description	Français	Picture	Qty/Bike	Model	GP187	GP157	GP107
1	YC110-1601-13-BKM	MINI GP aluminium frame MATT Black	Cadre aluminium MINI GP Noir MAT		1	GP107 GP157 GP187	X	X	X
2	YC110-1614-31-BKM	MINI GP aluminium subframe MATT Black	Boucle arriere aluminium MINI GP Noir MAT		1	GP107 GP157 GP187	X	X	X
3	YC110-1633-02	Rubber plug for SUBFRAME part d=16mm	Embout Caoutchouc YCF boucle arriere d=16mm		1	GP107 GP157 GP187	X	X	X
4	YC110-2201-02	YCF Chain tensioner component Nylon 2020	Roulette chaine YCF 2020 Nylon		1	GP107 GP157 GP187	X	X	X
8	YC110-1615-06-BKM	MINI GP aluminium left frame engine pads MATT Black	Patte de cadre gauche aluminium MINI GP Noir MAT		1	GP107 GP157 GP187	X	X	X

9	YC110-1616-06-BKM	MINI GP aluminium right frame engine pads MATT Black	Patte de cadre droite aluminium MINI GP Noir MAT		1	GP107 GP157 GP187	X	X	X
10	BT08-M8x30-W	Hexagonal Bolt M8x30mm for engine fixation	Vis M8x30mm pour fixation moteur		4	GP107 GP157 GP187	X	X	X
11	YC110-0834-01	Nord Lock M for Frame pads	Nord Lock Pattes de cadre		10	GP107 GP157 GP187	X	X	X
12	BT08-M8x30-W	Hexagonal Bolt M8x30mm for subframe	Vis M8x30mm pour boucle arriere		4	GP107 GP157 GP187	X	X	X
13	BT08-M8x115-W	Hexagonal Bolt M8x115mm	Vis M8x115mm		1	GP107 GP157 GP187	X	X	X
14	BT08-M8x125-W	Hexagonal Bolt M8x125mm	Vis M8x125mm		1	GP107 GP157 GP187	X	X	X
15	GB6187-M8-W	Self locking nut M8	Ecrou M8		6	GP107 GP157 GP187	X	X	X
16	YC110-1446-07	Bushing for Frame /swing arm axle d15mmxd23mmxd12mmx22mm d15mmxd12mmx20mm	Entretoise pour cadre / axe de bras oscillent d15mmxd23mmxd12mmx22mm d15mmxd12mmx20mm pour axe bras oscillent		2	GP107 GP157 GP187	X	X	X
17	YC110-1446-04	Bushing for Engine bottom plate 45# Steel d18mmxd12mmxd9mmx14mm Step 2mm	Entretoise de base de moteur 45# acier d18mmxd12mmxd9mmx14mm étape 2mm		4	GP107 GP157 GP187	X	X	X
18	YC110-1446-08	Bushing for frame pads ushing d15mmxd12mmxd8.3mmx10mm Step: d12mmxd8.3mmx8mm	Entretoise de patte de cadre d15mmxd12mmxd8.3mmx10mm step: d12mmxd8.3mmx8mm		2	GP107 GP157 GP187	X	X	X

19	YC110-1446-09	Bushing for inside Frame hanging plate mounting position bushing d15mmxd12mmxd8.3mmx10mm Step: d12mmxd8.3mmx6mm	Entretoise interieur de cadre d15mmxd12mmxd8.3mmx10mm step: d12mmxd8.3mmx6mm		2	GP107 GP157 GP187	X	X	X
20	YC110-1642-01-BKM	Foot fixing plate support aluminium bar d15mmx170mm Black	Barre aluminium transversale renfort d15mmx170mm Noir		1	GP107 GP157 GP187	X	X	X
21	GB70.2-M10x25-W	Pan head hexagon screw M10x25mm	Vis à tête ronde Allen (BTR) M10x25mm		2	GP107 GP157 GP187	X	X	X
22	GB97-d10-2W	Flat washer d10mm	Rondelle plate d10mm		2	GP107 GP157 GP187	X	X	X

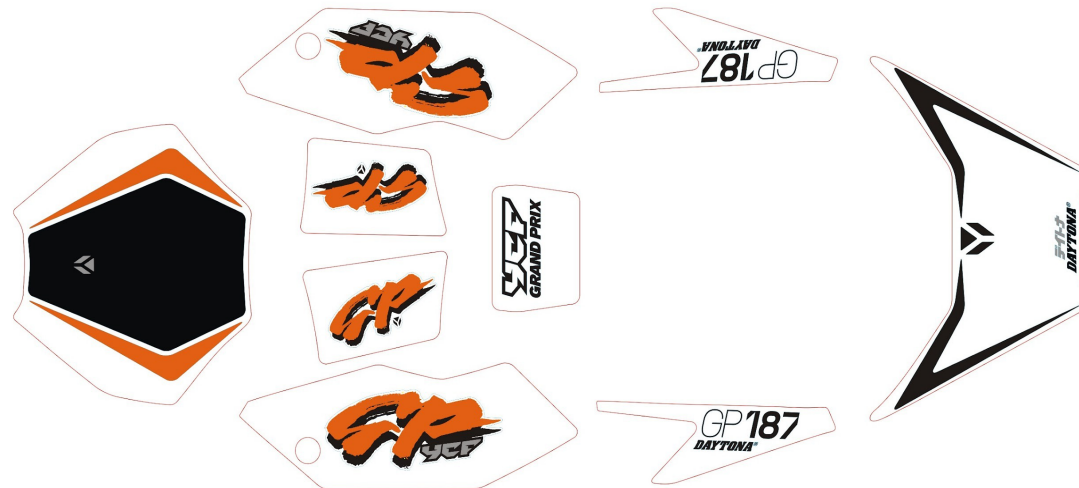
GRAPHICS



N°	Ref.	Description	Français	Picture	Qty/Bike	Model	GP187	GP157	GP107
1	KDGP1872023	MINI GP GP187 graphic kit	Kit deco MINI GP GP187		1	GP187	X		





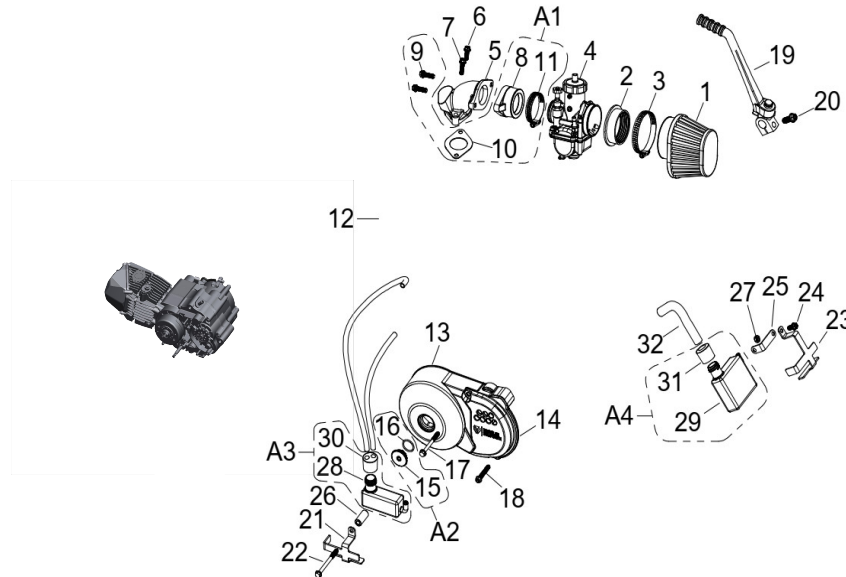





1	KDGP1572023	MINI GP GP157 graphic kit	Kit deco MINI GP GP157		1	GP157		X	
1	KDGP1072023	MINI GP GP107 graphic kit	Kit deco MINI GP GP107		1	GP107			X











ENGINES/CARBU /Air Filter





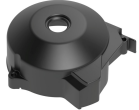









N°	Ref.	Description	Français	Picture	Qty/Bike	Model	GP187	GP157	GP107
1	KL-ZT-HP-55	NIBBI d55 for Carburetor BIBBI PE34	NIBBI d55 four carburateur BIBBI PE34		1	GP187 GP157 GP107	X	X	X
2	YC110-0836-0401	Carburetor d49mm rubber connexion for d54mm Air filter	Connexion caoutchouc d49mm pour carburateur d54mm		1	GP187 GP157 GP107	X	X	X

2	YC110-0836-04	Carburetor d45 rubber connexion for d49 Air filter	Connexion caoutchouc d45 pour carburateur d49 mm		1	GP157 GP107			X
4	PE28SP	Nibbi carburetor PE28	Carburateur Nibbi PE28		1	GP187	X	X	
4	PE24SP	NIBBI Carburetor PE24SP	Carburateur NIBBI PE24SP		1	GP157 GP107			X
4	LK-PE-100	Main Jet 100 PE Nibbi	Gicleur principal 100 PE Nibbi		1	GP107			X
4	LK-PE-110	Main Jet Nibbi	Gicleur principal Nibbi		1	GP157		X	
4	LK-PE-118	Main Jet 118 PE Nibbi	Gicleur principal 118 PE Nibbi		1	GP187	X		
4	LK-FLK-40	Slow Jet 40 FLK Nibbi	Gicleur ralenti 40 FLK Nibbi		1	GP157 GP107		X	X
4	LK-FLK-42	Slow Jet 42 FLK Nibbi	Gicleur ralenti 42 FLK Nibbi		1	GP187	X		
5	86404	Manifold, intake for Daytona Animaengine	Pipe d'admission Daytona Anima		1	GP187	X		
5	17311-13	Manifold, intake for GP157 FA/7H	Pipe d'admission pour GP157 FA/7H		1	GP157		X	

5	17311-12	Manifold, intake for GP107 24/ZL	Pipe d'admission pour GP107 24/ZL		1	GP107			X
6	BT08-M6x20-W	Hexagonal Bolt M6x20mm for inlet pipe fixation (on engine)	Vis M6x20mm pour fixation pipe admission (sur moteur)		1	GP187	X		
6	BT08-M6x20-W	Hexagonal Bolt M6x20mm for inlet pipe fixation (on engine)	Vis M6x20mm pour fixation pipe admission (sur moteur)		2	GP157 GP107		X	X
7	BT08-M6x25-W	HEXAGON Torx screw with Flange M6x25mm	Vis HEXAGONALE Torx avec Flange M6x25mm		1	GP187	X		
A1	46758	Rubber manifold set (with YC50-0803 1EA+YC110-2029 1EA+GB70-M6x30-W 2EA)	Manchon pipe admission Daytona		1	GP187	X		
8	17315	Rubber adaptator for VM24/PE27	MANCHON CARBU SOUPLE pour VM24/PE27		1	GP157		X	
9	BT08-M6x16-W	HEXAGON Torx screw with Flange M6x16mm	Vis HEXAGONALE Torx avec Flange M6x16mm		2	GP187 GP157 GP107	X	X	
9	BT08-M6x30-W	HEXAGON Torx screw with Flange M6x30mm	Vis HEXAGONALE Torx avec Flange M6x30mm		2	GP107			X
9	GB6177-M6-W	Hex. Flanged nut M6	écrou M6		2	GP107			X
10	17332/152FMH01	Intake Gasket	JT PAPIER PIPE ADMISSION		1	GP107			X

10	F00C039	carburettor isolating gasket d27.5mm	joint plastique carburateur d27.5mm		1	GP107			X
10	YC110-2029	YCF carburettor paper gasket	Joint papier carburateur		1	GP187	X	X	
10	17332	carburettor paper gasket d28mm	joint papier carburateur d28mm		1	GP157 GP107			X
12	87615	Daytona engine 190cc 4 Valves FDX	Moteur Daytona ANIMA 190cc 4 valves FDX		1	GP187	X		
12	MOTEUR155-G	Zongshen Fiddy Engine 150cc	Moteur Zongshen Fiddy 150cc		1	GP157		X	
12	MOTEUR110-G	Engine 110-G	Moteur 110-G		1	GP107			X
13	YC110-2004-01-BKM	YCF Crankcase Cover, LH for kick start engine Black mat	Carter moteur allumage aluminium YCF Noir mat		1	GP107 GP157 GP187	X	X	X
14	YC110-1803-02-BK	YCF B--material Front Sprocket plastic cover for kick start engine Black	Protection composite YCF PSB pour moteur demarage avec kick Noir		1	GP107 GP157 GP187	X	X	X
A2	YC110-20141	YCF Aluminium Complete Cap Big View Hole BLUE (without logo)	Bouchon carter allumage Complet CNC YCF BLEU (sans logo)		1	GP107 GP157 GP187	X	X	X
17	GB5787-M6x40-Cr	Screw M6x40mm	Vis M6x40mm		1	GP107 GP157 GP187	X	X	X

18	GB5787-M6x25-Cr	Screw M6x25mm	Vis M6x25mm		1	GP107 GP157 GP187	X	X	X
19	YC140-27600SI	Steel kick YCF 2015 big hole SILVER	Kick acier YCF gros diametre SILVER		1	GP157 GP187	X		
19	YC140-27500-SI	STEEL KICK YCF 2015 Small hole	KICK ACIER 2015 petit diametre SILVER		1	GP107		X	X
20	BT08-M8x25-W	Hexagonal Bolt M8x25mm for kiskstart	Vis M8x25mm pour kick		1	ALL BIKES 23	X	X	X
22	GB5787-M6x55	Screw M6x55mm	Vis M6x55mm		1	GP107 GP157 GP187	X	X	X
24	BT08-M6x12-W	Hex.Bolt M6x12mm for oil tank fixation	Vis pour fixation patte recuperateur huile M6x12mm		1	GP107 GP157 GP187	X	X	X
25	YC110-86-01	The engine YouHu stents MINI GP	PATTE DE RECUPERATEUR HUILE MINI GP		1	GP107 GP157 GP187	X	X	X
26	YC110-8801-02	Bushing Aluminum d12mmxd7mmx27mm	Bague aluminium d12mmxd7mmx27mm		1	GP107 GP157 GP187	X	X	X
27	GB6177-M6-W	Hex. Flanged nut M6	écrou M6		1	GP107 GP157 GP187	X	X	X
A3	YC110-80-BK	Gas tank (small)	Bac Recuperateur essence (petit)		1	GP107 GP157 GP187	X	X	X

A4	YC110-8201-BK	Oil and / gas tank (big)	Bac Recuperateur essence / huile (grand)	 1	GP107 GP157 GP187	X	X	X
35	YC110-01-03-BK	Cable tie 150mm BLACK	Collier maintien cable 150mm NOIR	 4	GP107 GP157 GP187	X	X	X



Recommended order parts
1
6
2
10

10
5

1
2

3
1
1

10

1

2

3
2
1
1

2
2
2
2

4
10

4
10
3
1

1
1
1
1
3
2

2

5

3

2

1
1
1
1
1

1
1
1
1

1
2
2
2
5
3
3
10

10
3
3
3
3
3
3

1
1
1

1



